

Patty's Primary Songs

Printable resources from Patty's Primary Songs website to enhance learning through worksheets, coloring pages and activities for preschool and kindergarten



Workbook

www.PattysPrimarySongs.com

5 Little Bunnies

NAME: _____

How many bunnies are in each box?

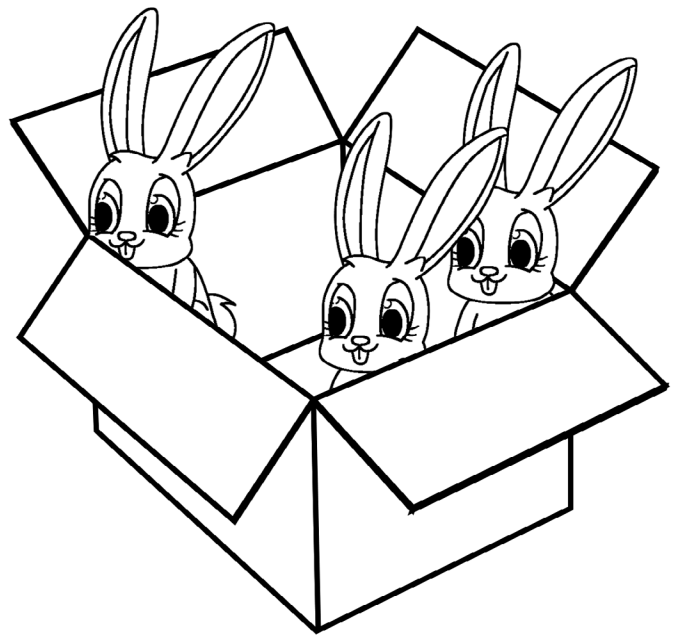
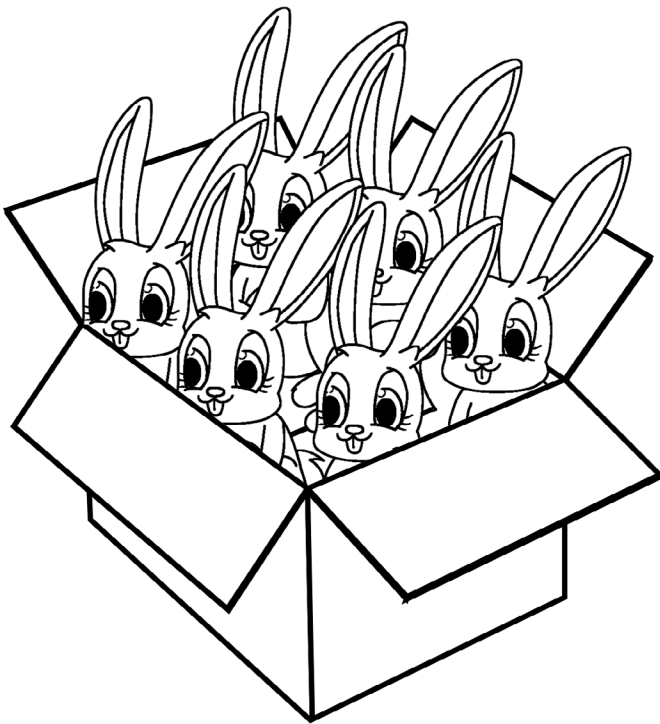
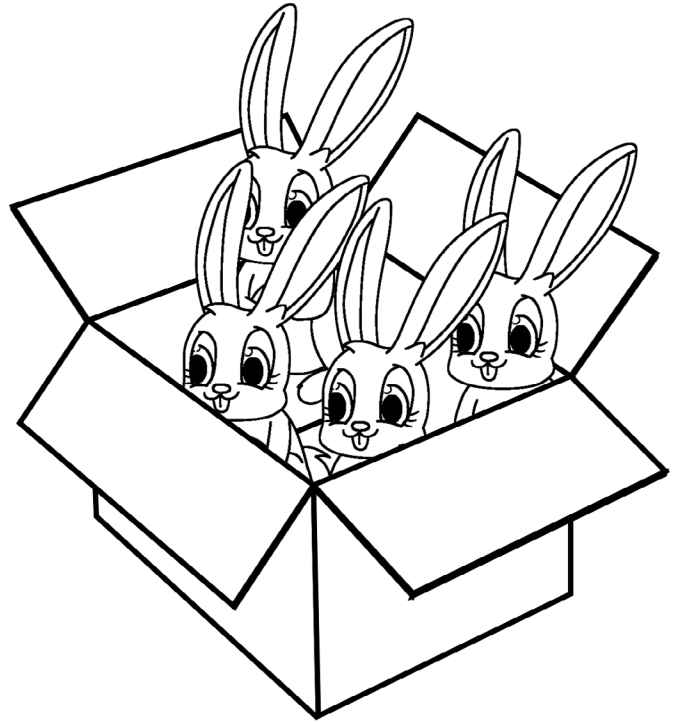
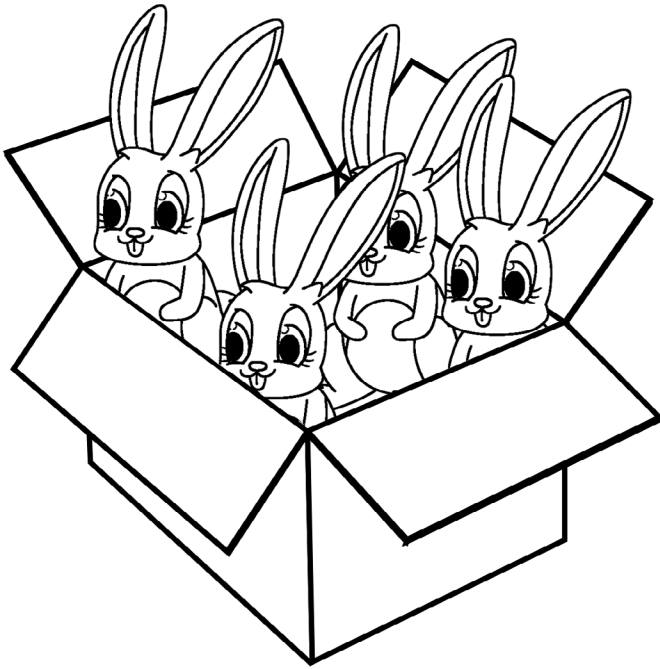

8 Planets in the Solar System

NAME: _____

Trace the names of each planet.



Mercury



Venus



Earth

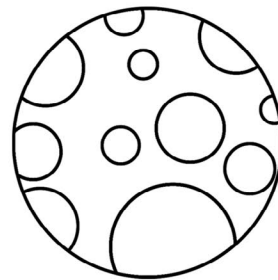

Mars

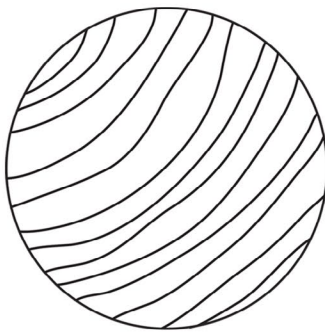

Jupiter

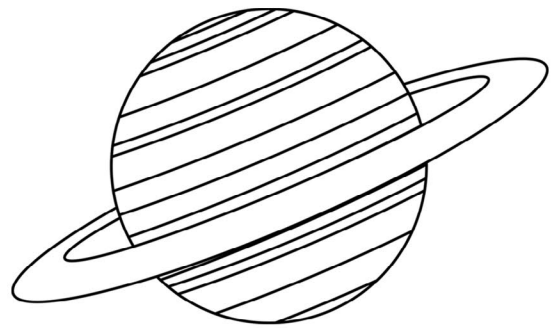

Saturn

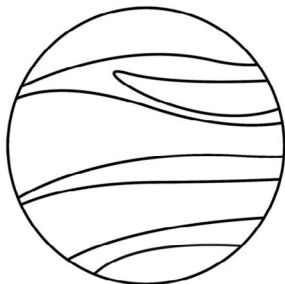

Uranus

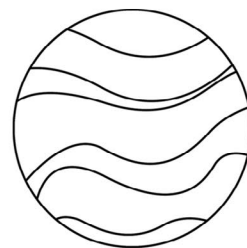

Neptune

Animal Phonics

NAME: _____

Practice writing. Trace the alphabet.

Aa Bb Cc Dd

Ee Ff Gg Hh

Ii Jj Kk Ll

Mm Nn Oo Pp

Qq Rr Ss Tt

Uu Vv Ww Xx

Yy Zz

Bananas

NAME: _____

Trace the letter B upper case and lower case b many times.

Bb

Bb

Bb

Bb

Bb

Bb

Bb

Bb

Bb

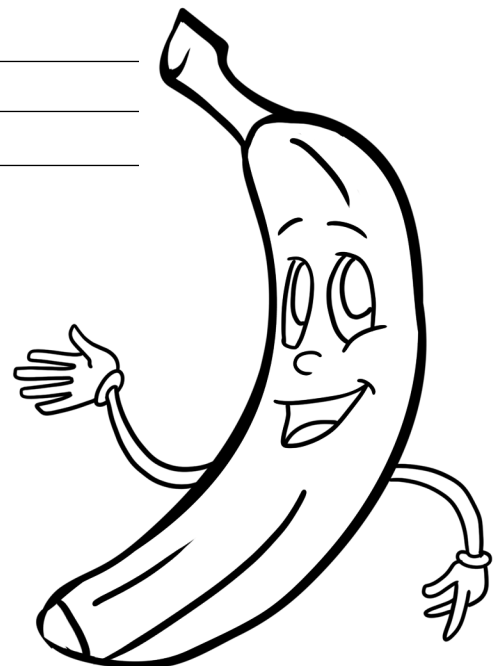

Be a Doctor

NAME: _____

Coloring.

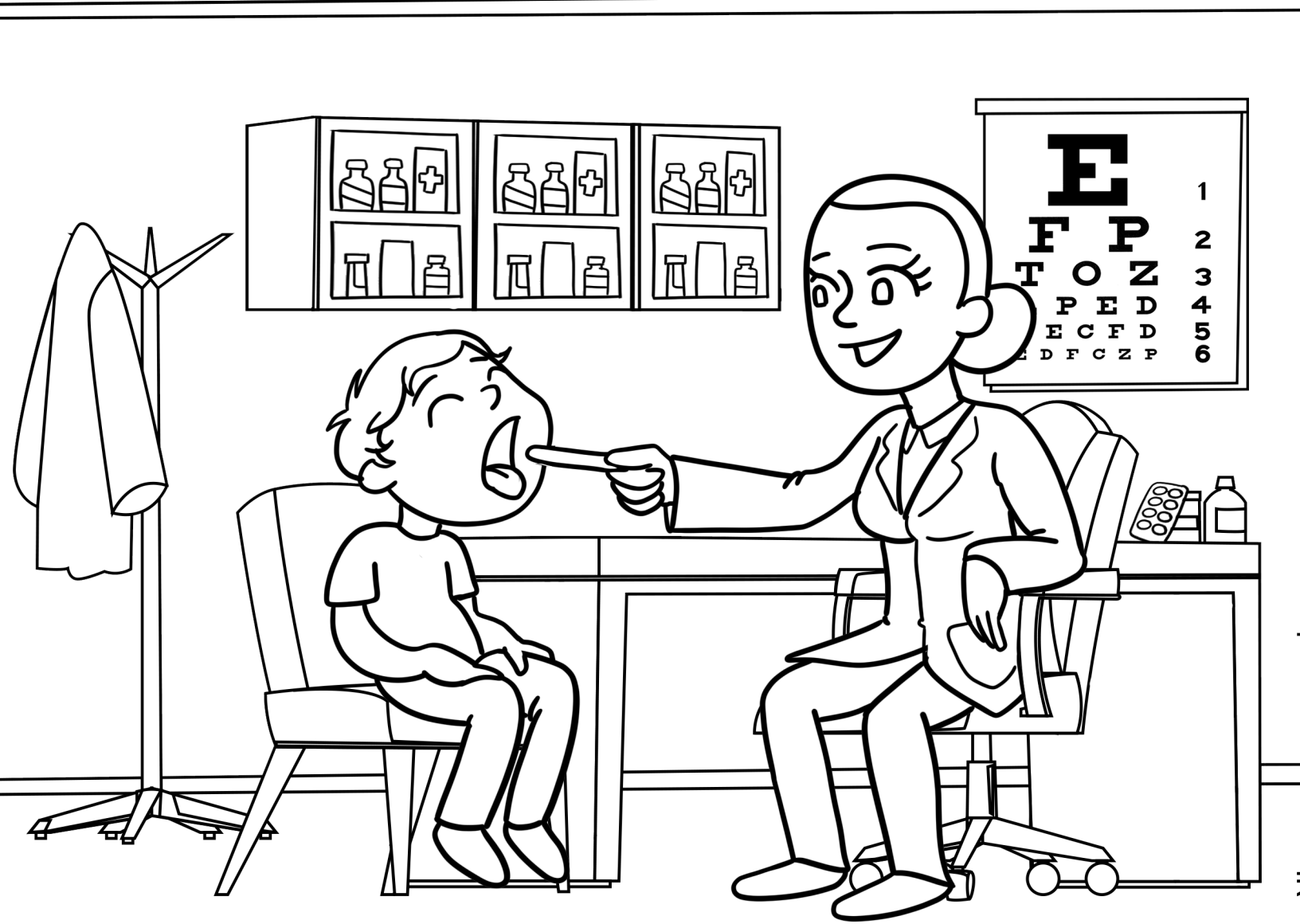

Be a Pilot

NAME: _____

Coloring

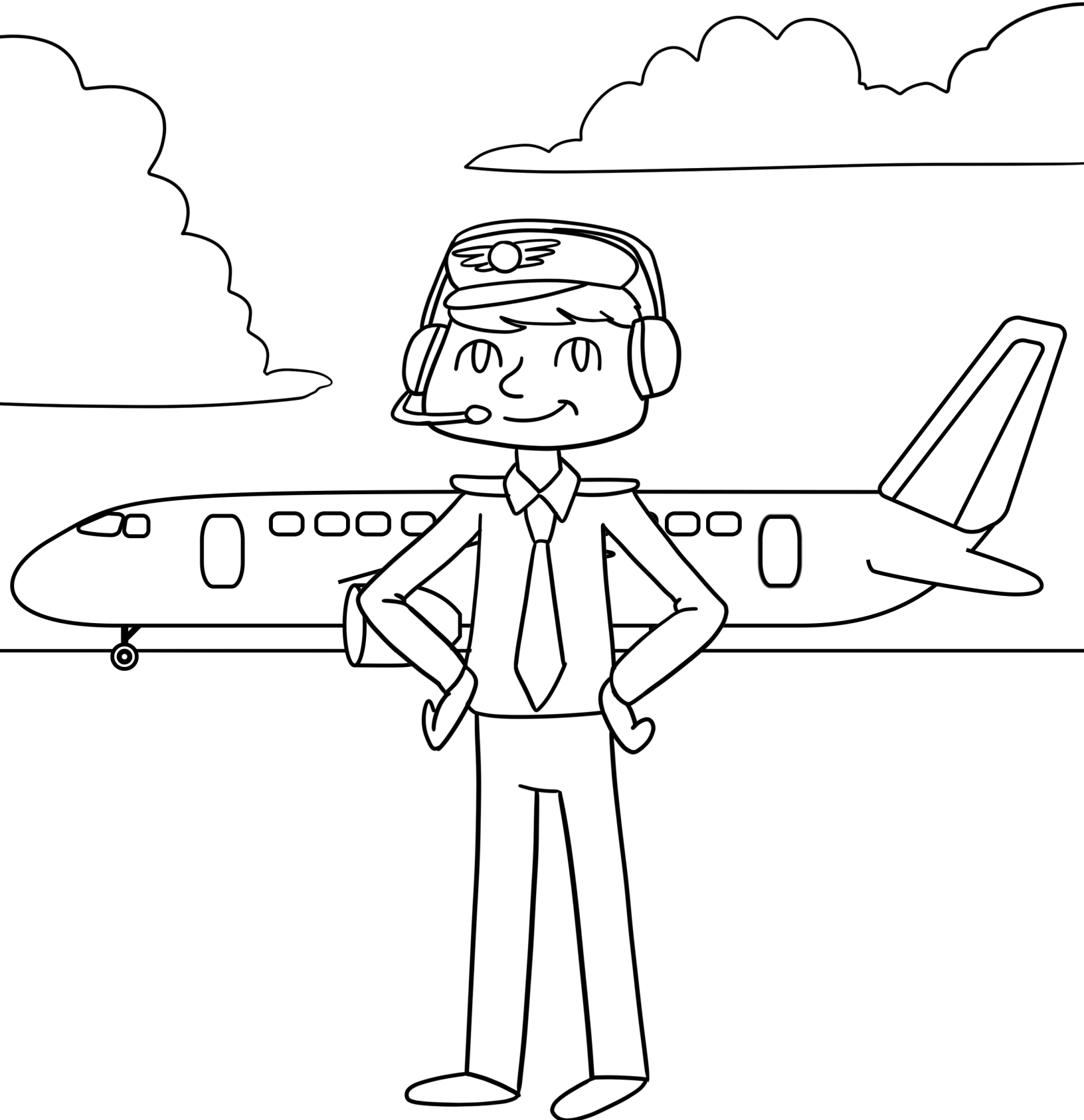

Be Responsible, Be Safe, Be Respectful

NAME: _____

Coloring

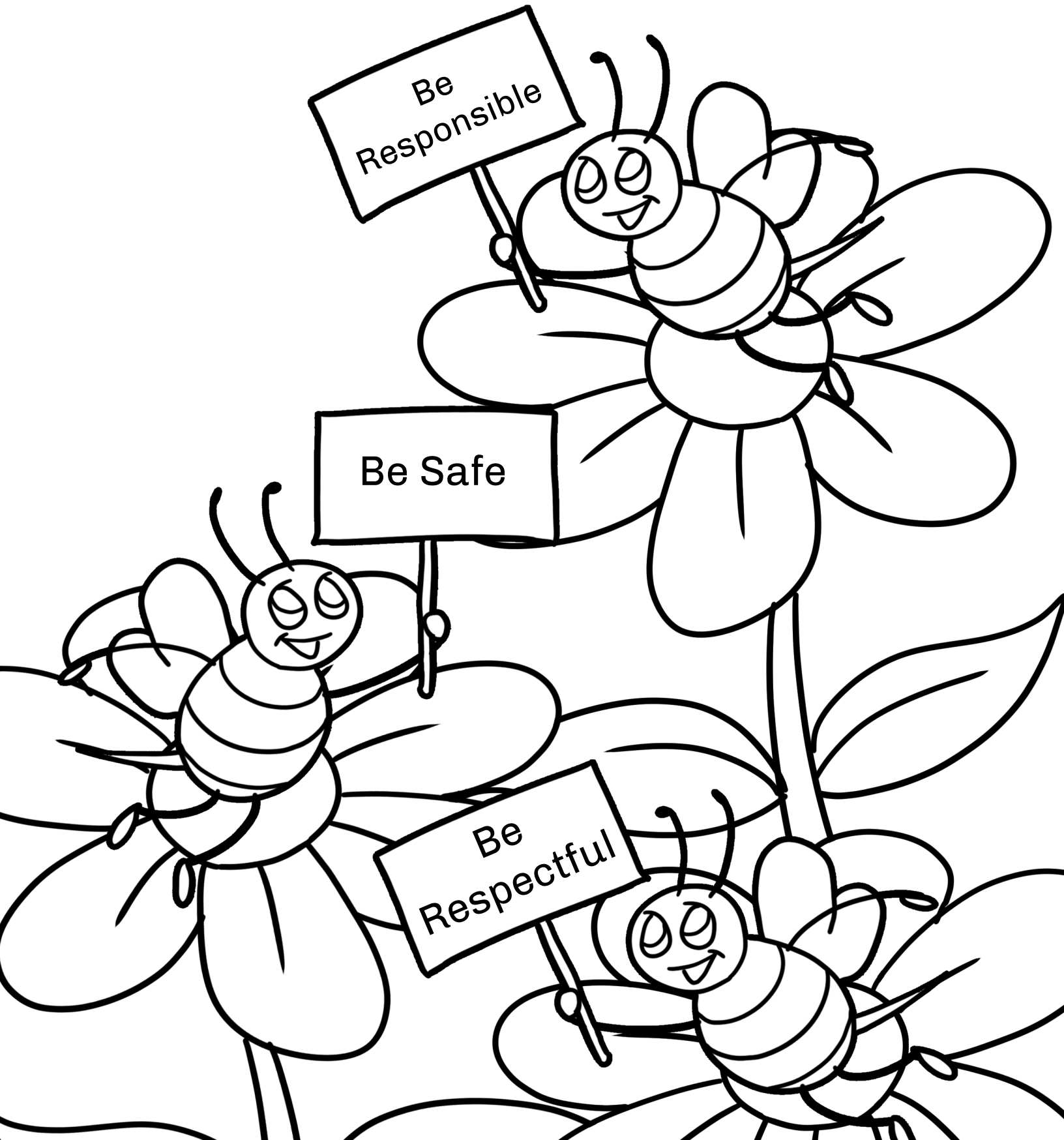

BL Blend Words

NAME: _____

Say the name of the picture. Fill in the letters that make the beginning sound.
Color the picture.

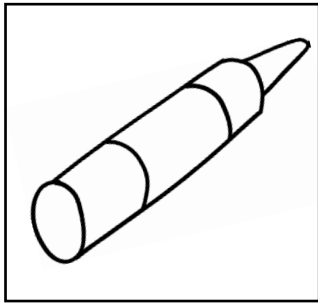

__ack

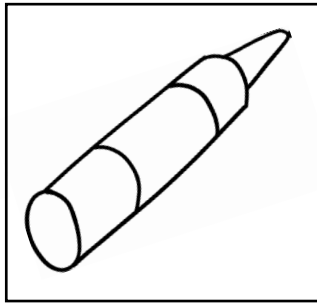

__ue

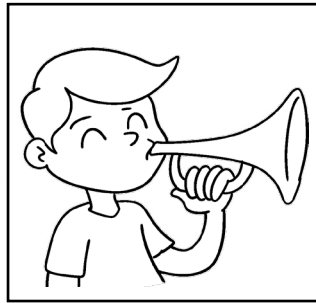

__ow

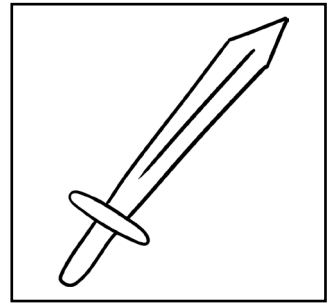

__ade



__ind



__ew

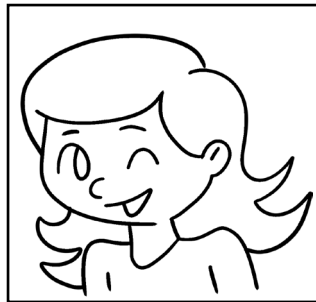

__ink



__uff

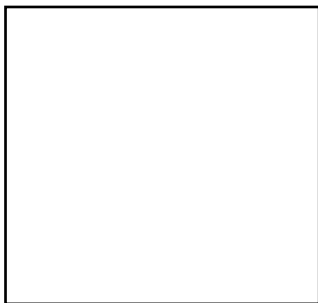

__ank

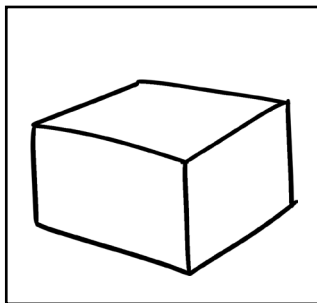

__ock

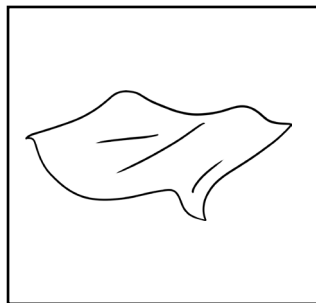

__anket

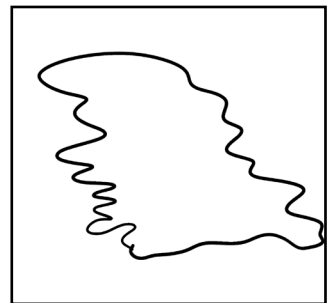

__ur

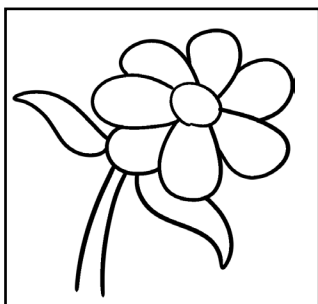

__oom

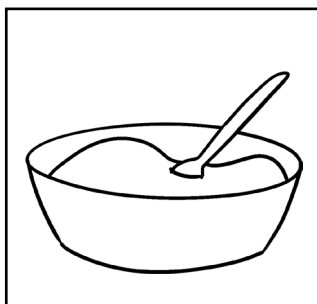

__end

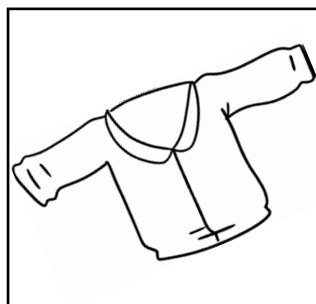

__ouse

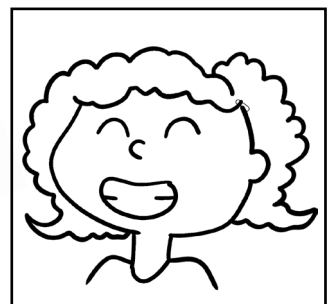

__ush

Bouncing Up and Down

NAME: _____

Coloring. How tall are you?

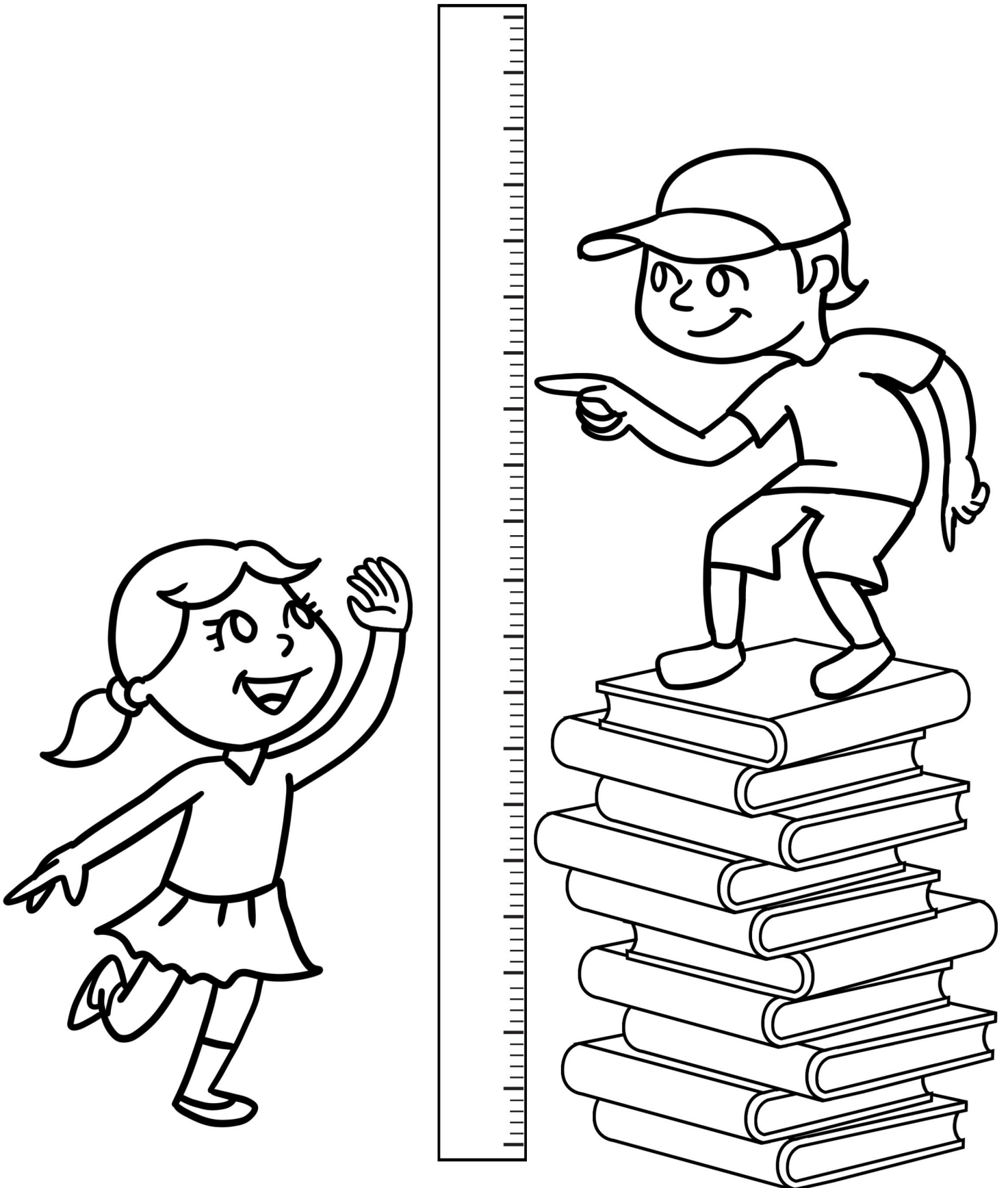

BR Blend Words

NAME: _____

Say the name of the picture. Fill in the letters that make the beginning sound.
Color the picture.

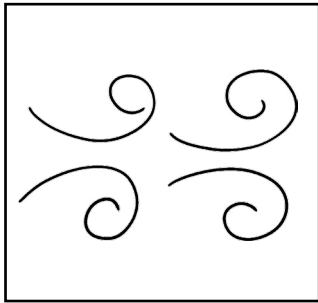

__eeze

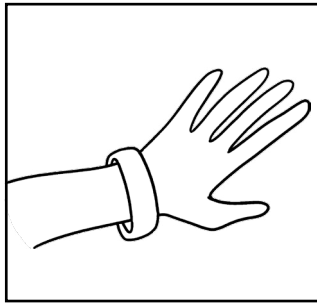

__acelet

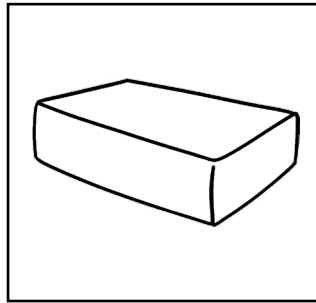

__ick

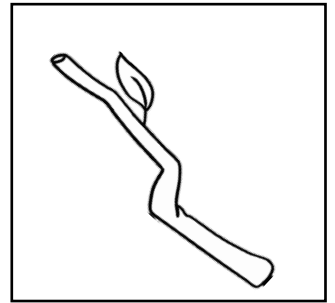

__anch



__and

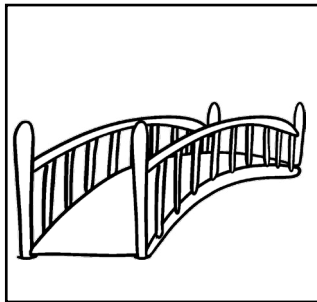

__idge

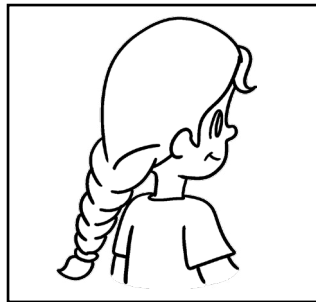

__aid

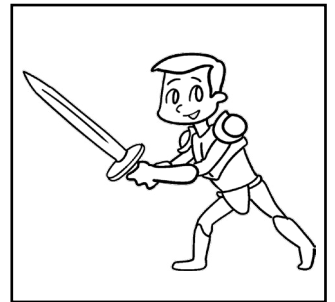

__ave

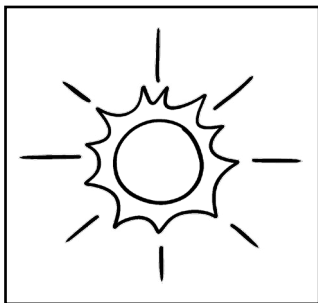

__ight

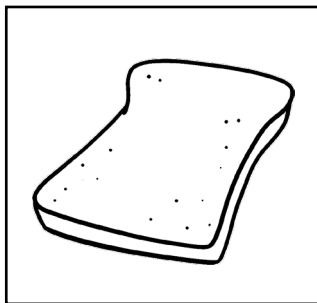

__ead

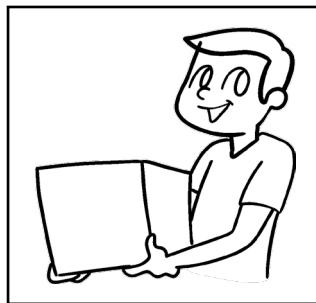

__ing

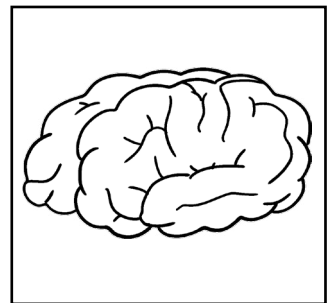

__ain

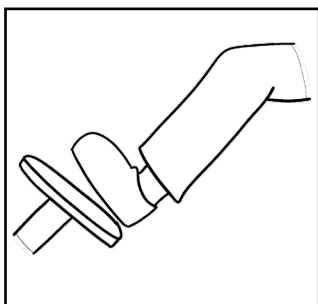

__ake

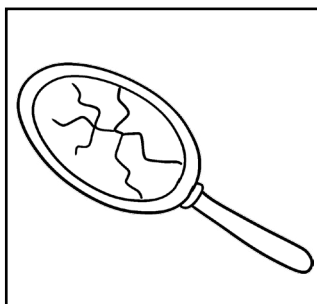

__oke

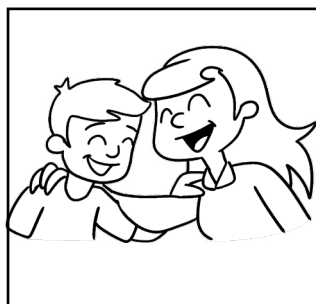

__other

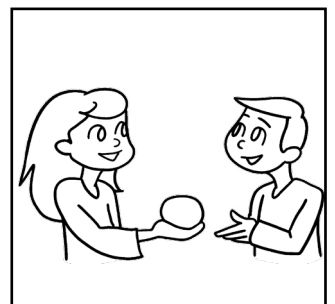

__ought

Brush My Chompers

NAME: _____

Help the toothbrush find the smiling teeth

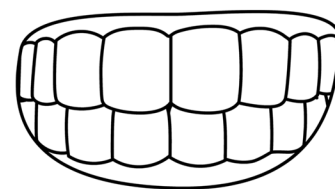
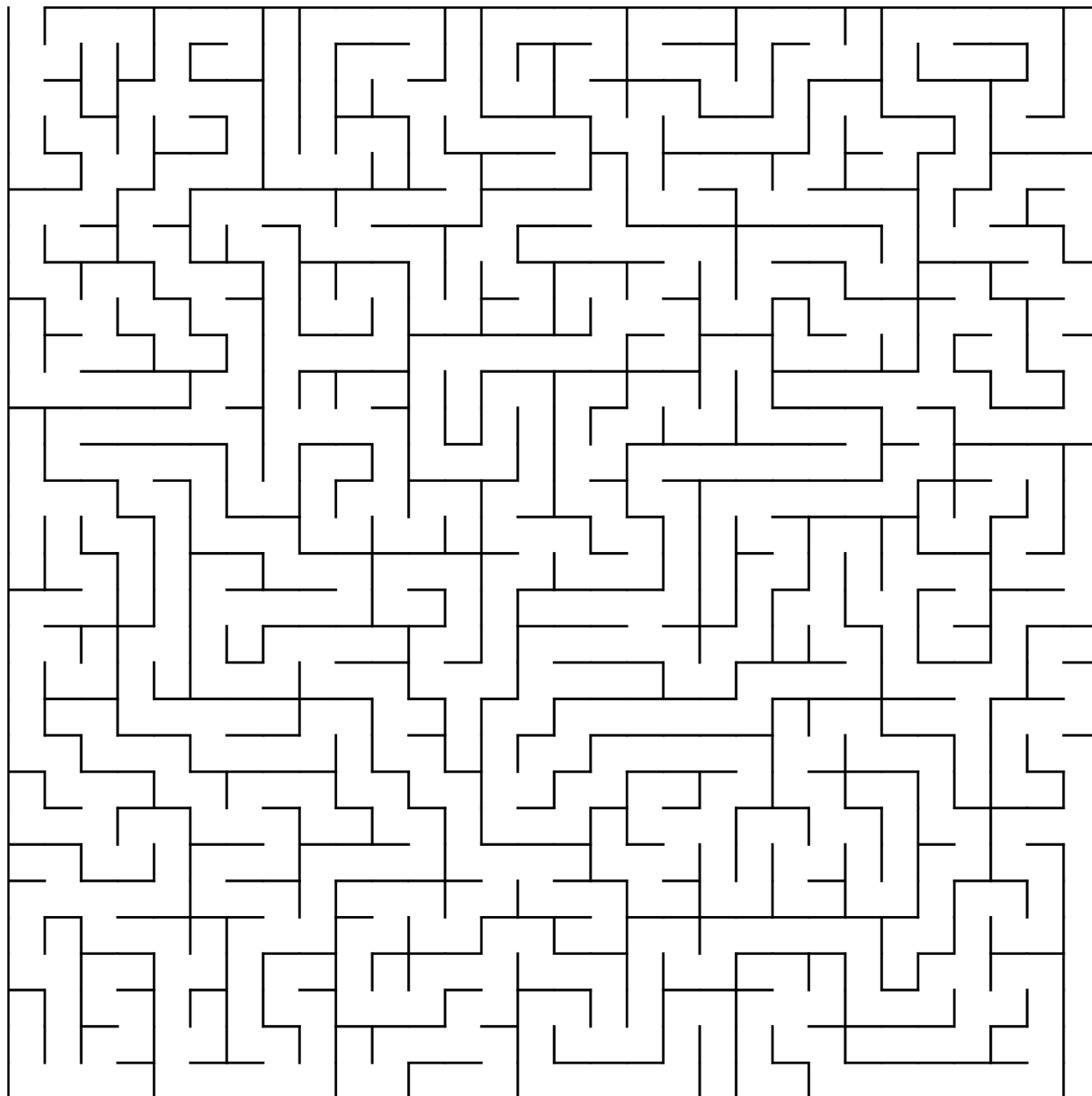

Bunny Hop

NAME: _____

Coloring

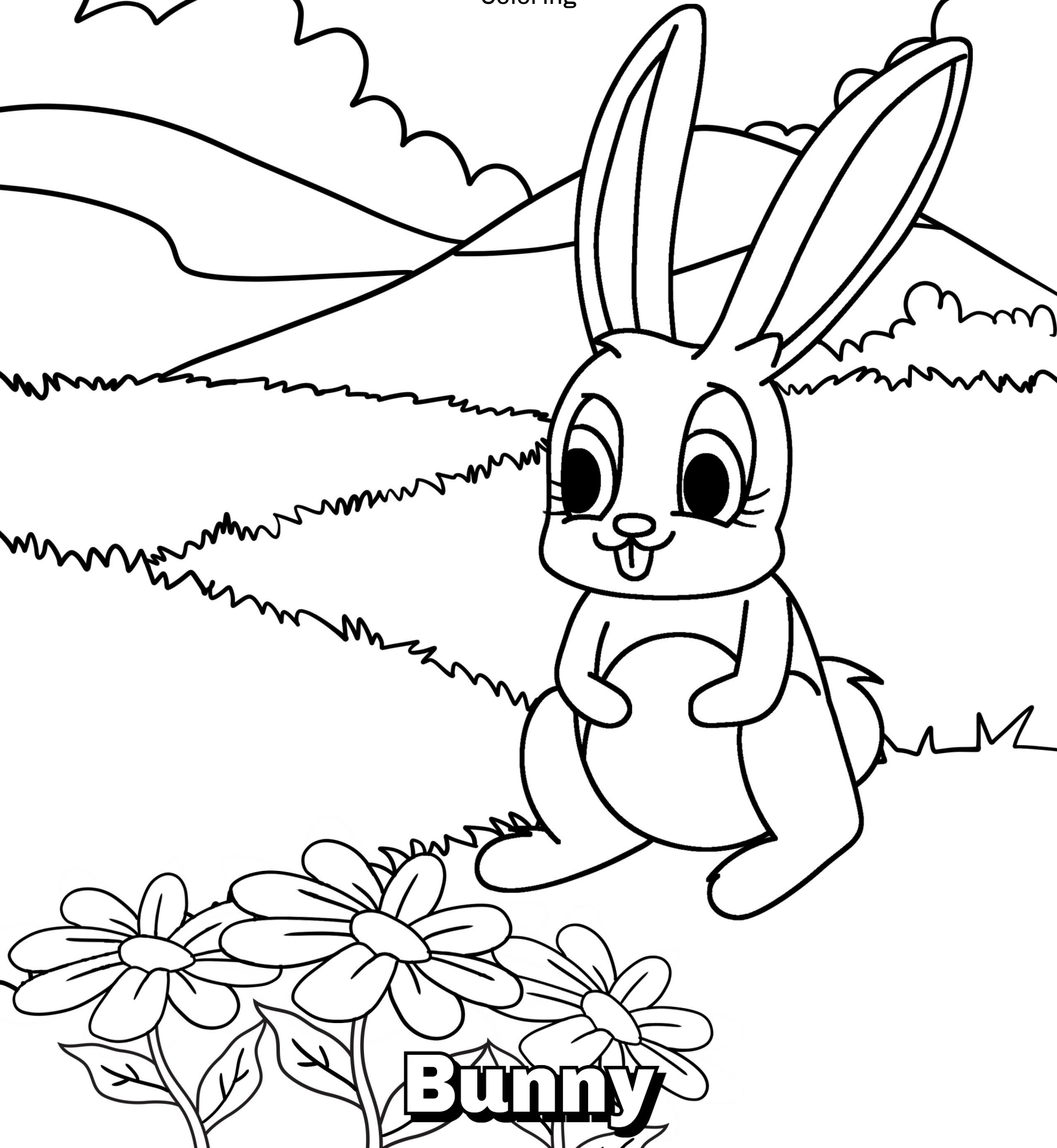

Butter Fly Dance

NAME: _____

Coloring

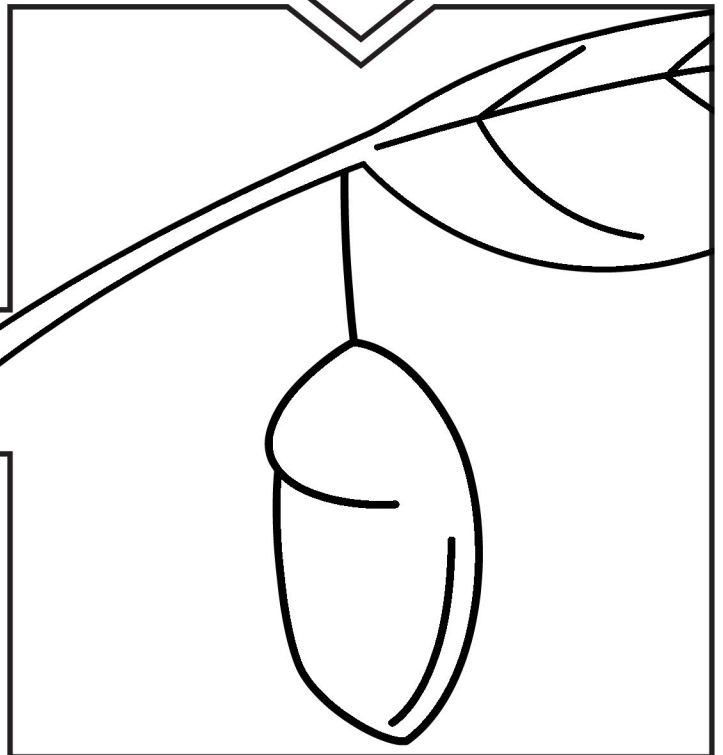
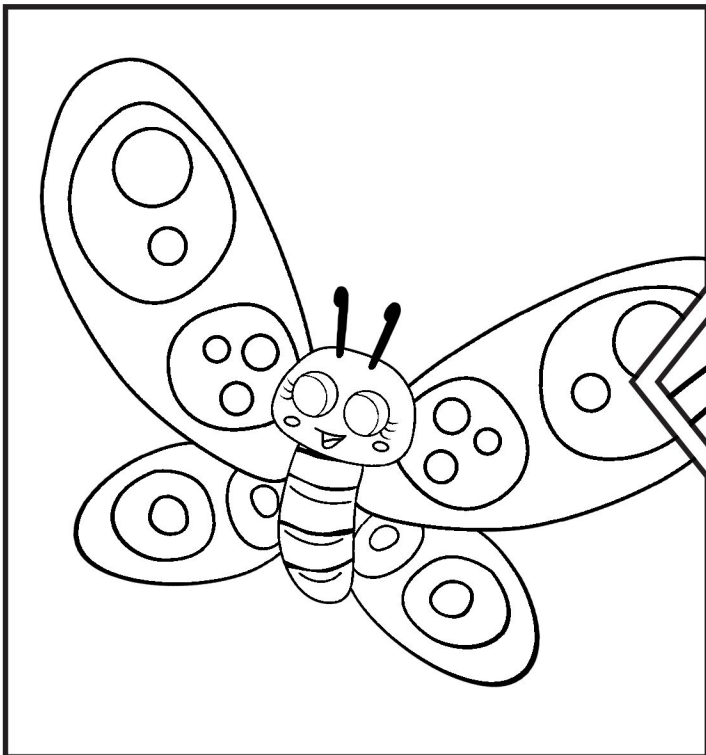
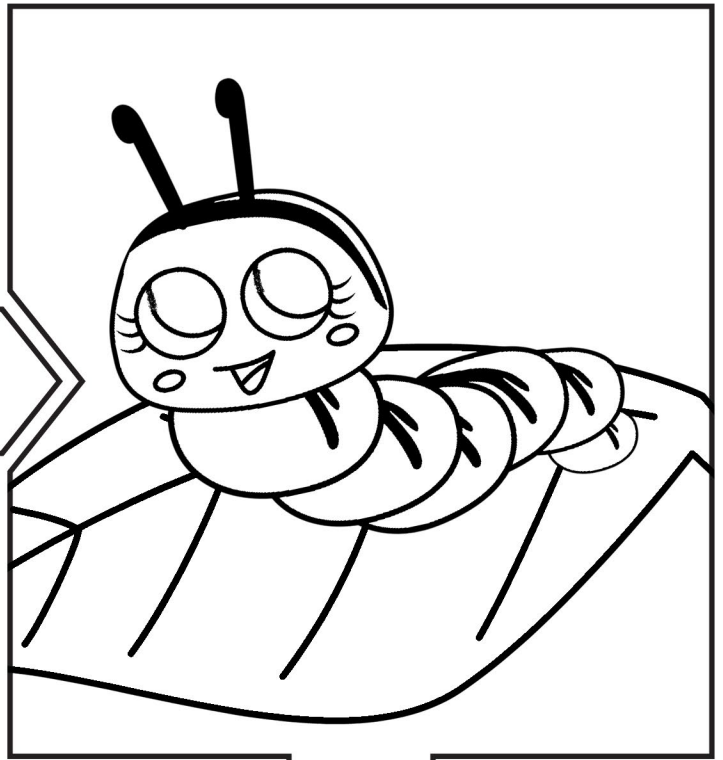
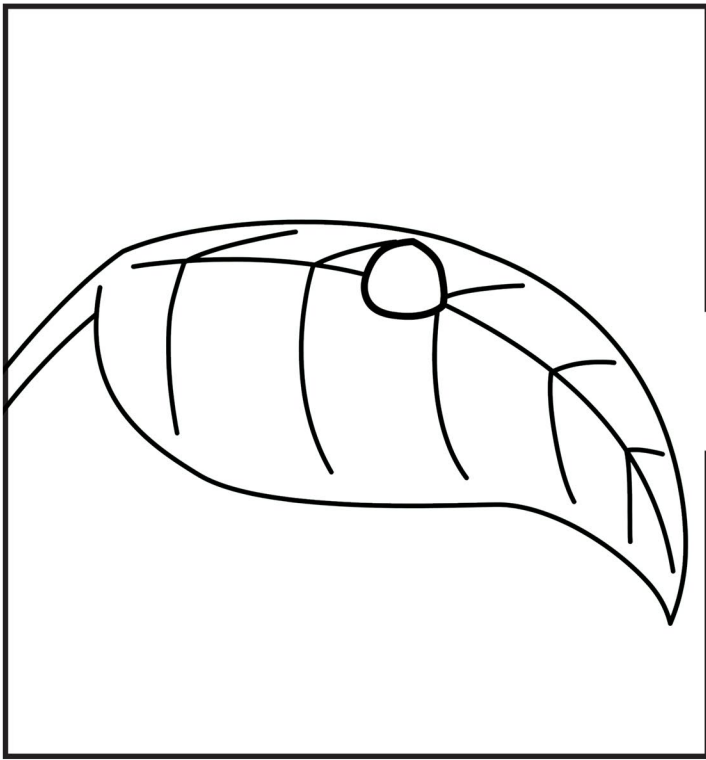

CH Blend Words

NAME: _____

Say the name of the picture. Fill in the letters that make the beginning sound.
Color the picture.

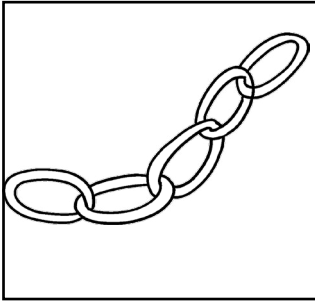

__ain

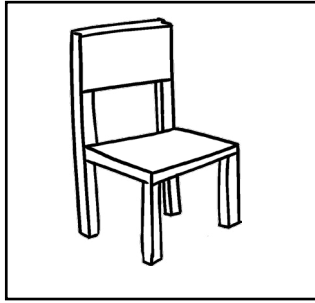

__air

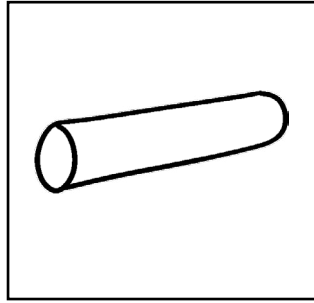

__alk

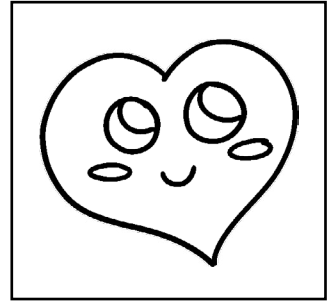

__arm

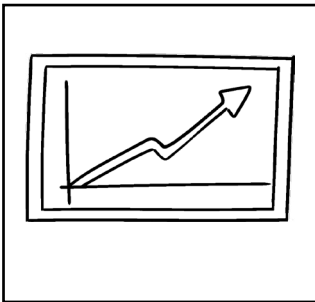

__art

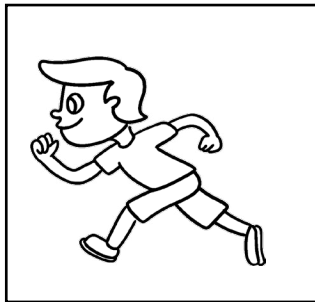

__ase

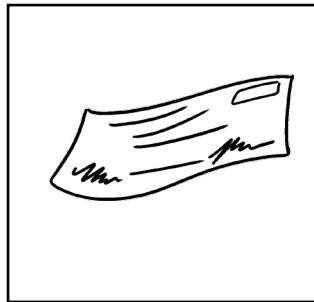

__eck

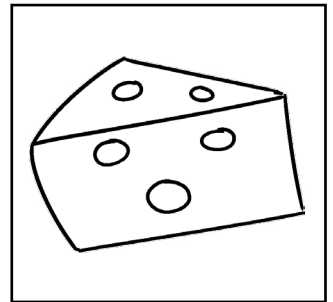

__eese

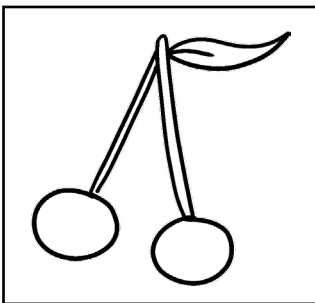

__erry

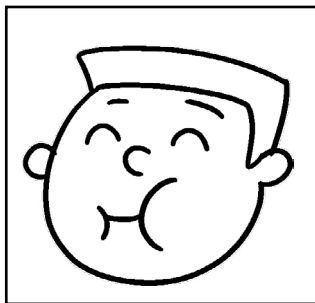

__ew

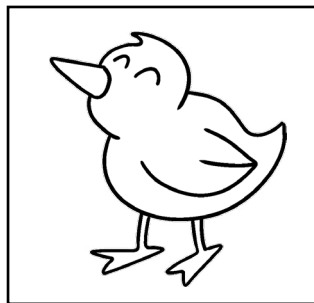

__ick

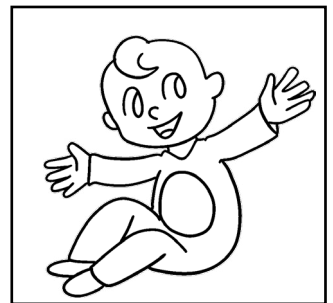

__ild

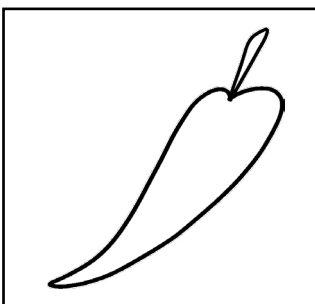

__ili

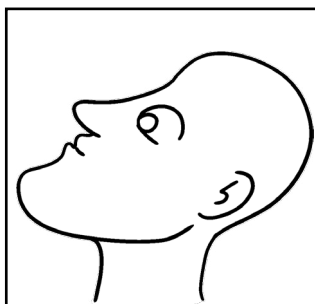

__in

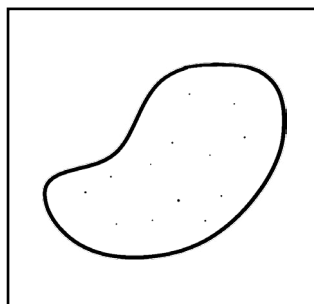

__ip

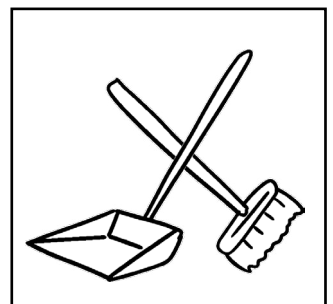

__ore

Check the Weather

NAME: _____

Color the picture and draw a line to the correct word.

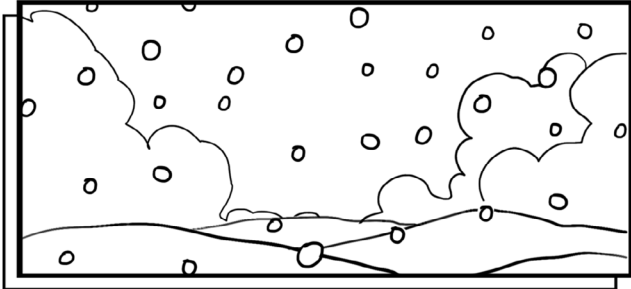

cloudy



rainy

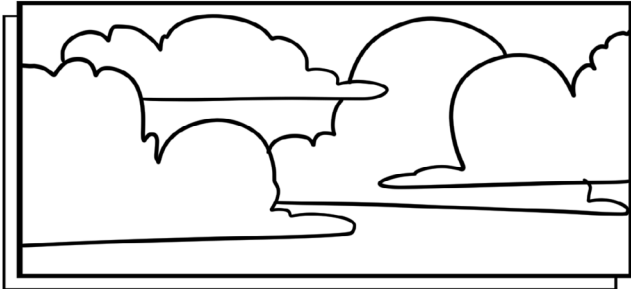

sunny

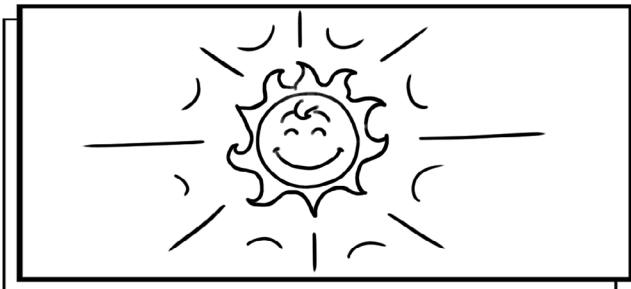

snowy

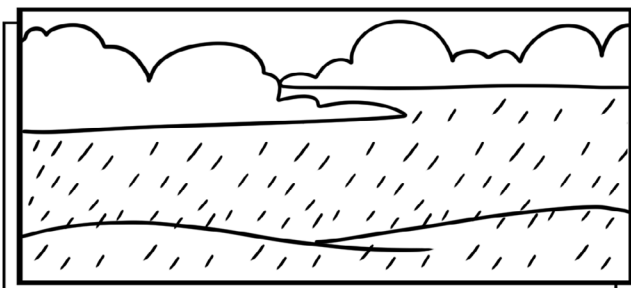

windy

Circles and lines

NAME: _____

Trace the alphabet letters

Aa Bb Cc Dd

Ee Ff Gg Hh

Ii Jj Kk Ll

Mm Nn Oo Pp

Qq Rr Ss Tt

Uu Vv Ww Xx

Yy Zz

CL Blend Words

NAME: _____

Say the name of the picture. Fill in the letters that make the beginning sound.
Color the picture.

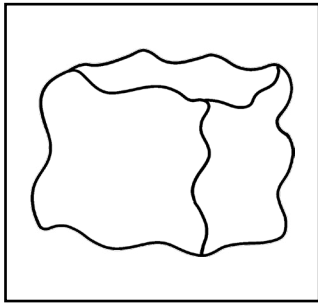

__ay

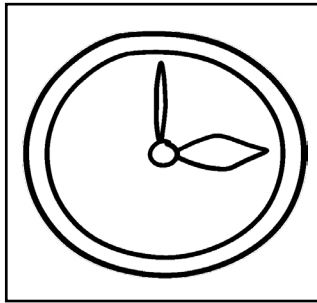

__ock

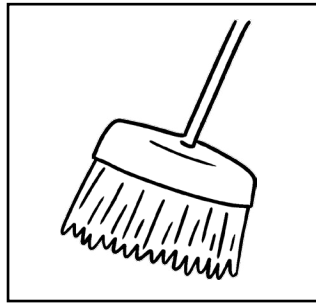

__ean

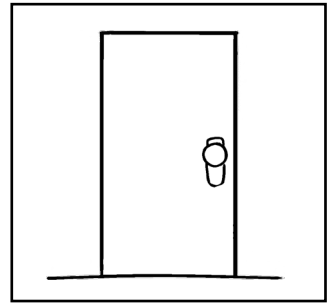

__ose

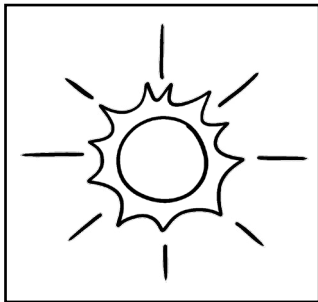

__ear

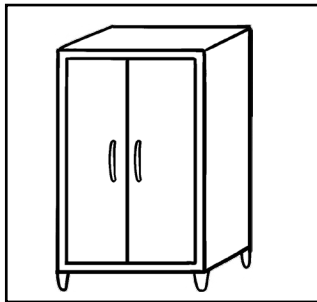

__oset

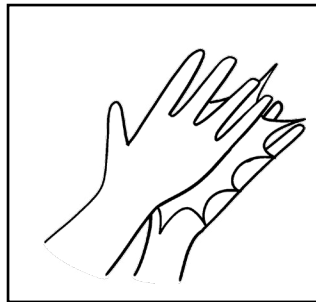

__ap

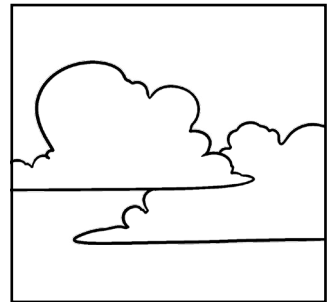

__oud

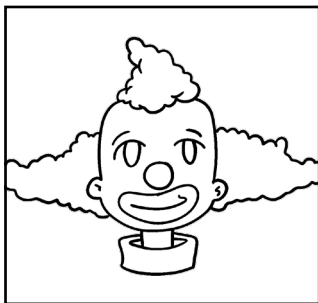

__own

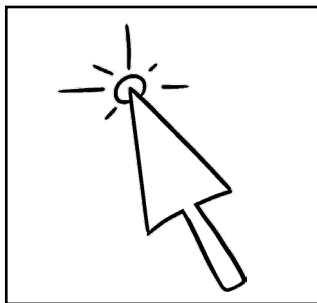

__ick

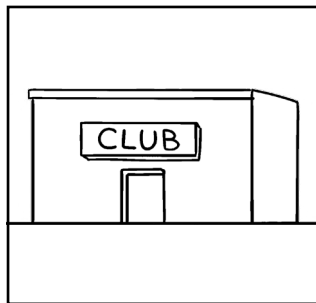

__ub

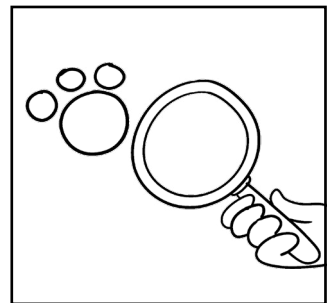

__ue

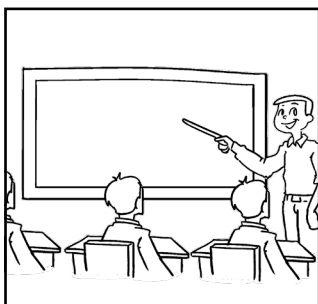

__ass



__imb

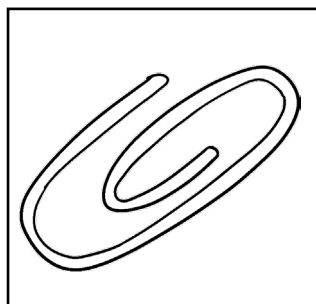

__ip

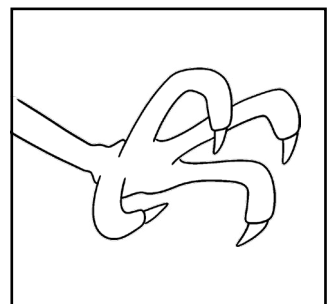

__aw

Compound Words

NAME: _____

Match the compound words. Draw a line to match the two parts of a compound word.

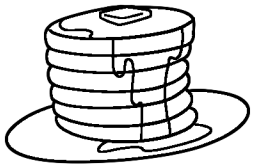

pan

pack

in

box

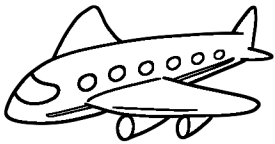

air

cake

play

fish

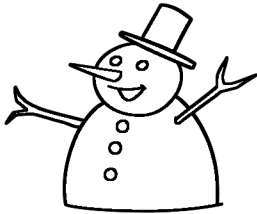
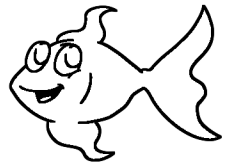

ice

ball

sun

side



back

work

gold

set

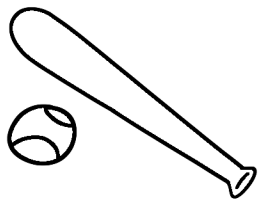
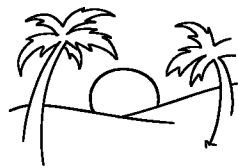

base

plane

mail

coat

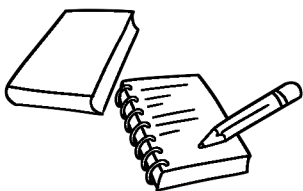
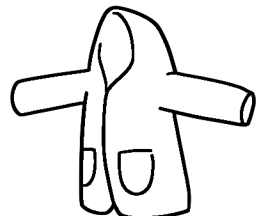

home

cream

rain

ground



Doubles

NAME: _____

Add the number of elements in each row and write the answer in the space given.

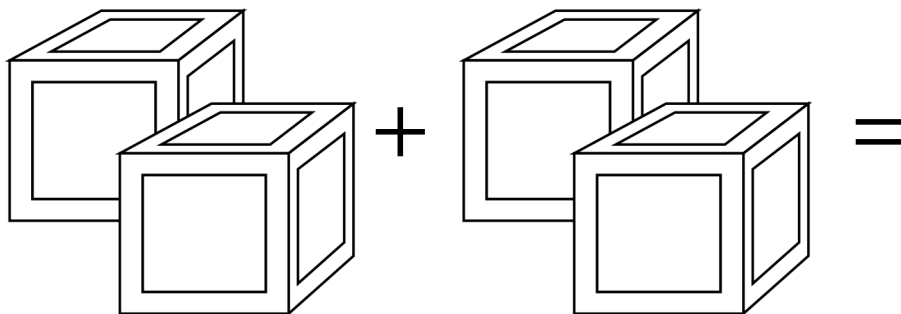

_____ + _____ = _____

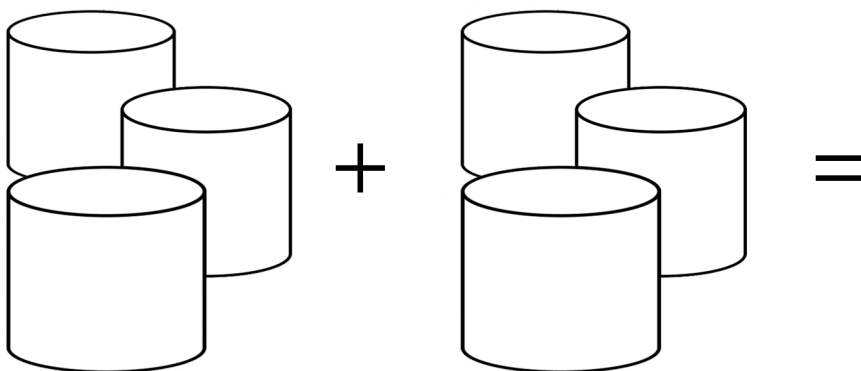

_____ + _____ = _____

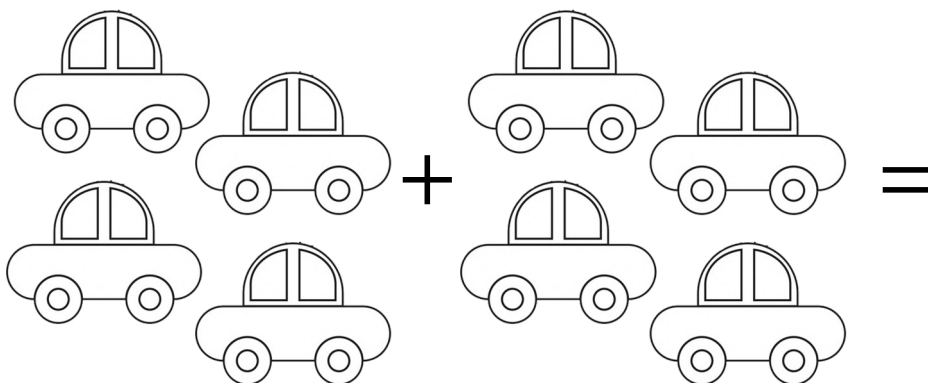

_____ + _____ = _____

DR Blend Words

NAME: _____

Say the name of the picture. Fill in the letters that make the beginning sound.
Color the picture.



__ ink

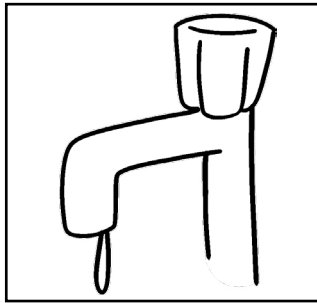

__ ip

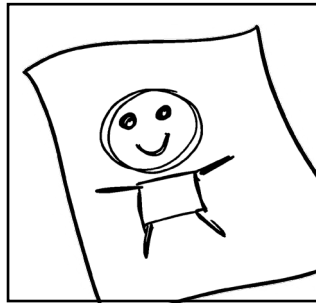

__ aft

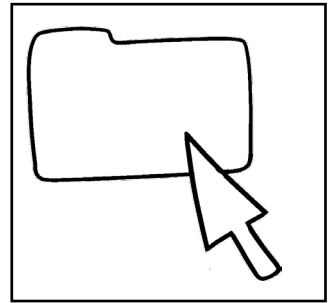

__ ag

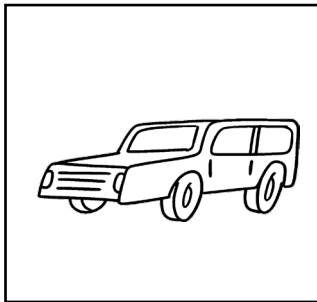

__ ive

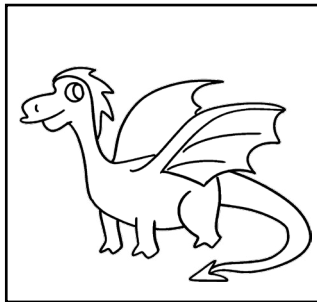

__ agon



__ eam

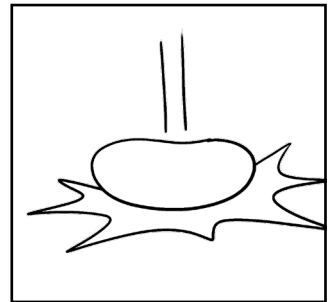

__ op

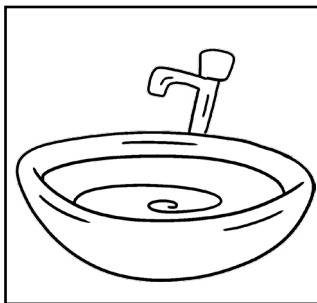

__ ain

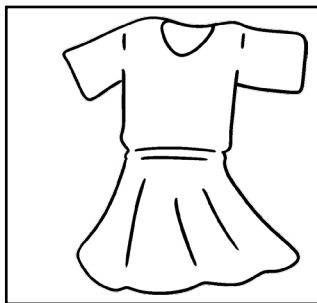

__ ess

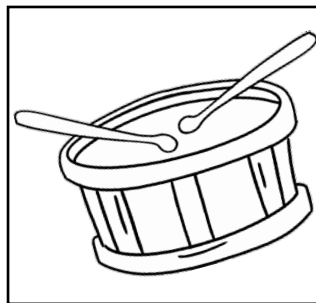

__ um

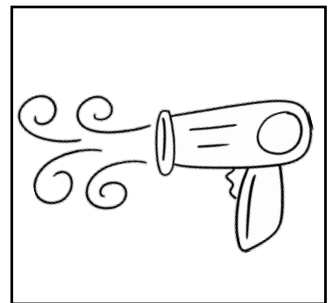

__ ied

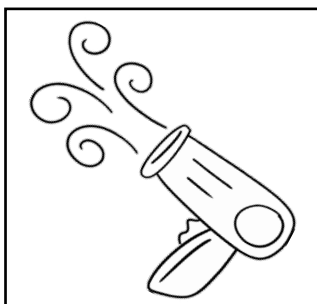

__ y

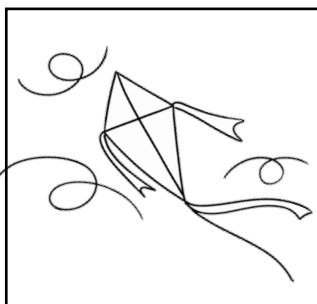

__ ift

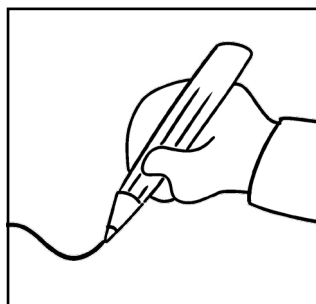

__ aw

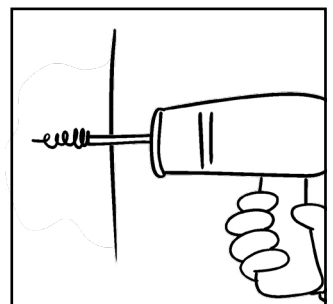

__ ill

Feelings

NAME: _____

Write the emotions



Fifty States of America

NAME: _____

Color the states. Color the state you live in red. Color the states you visited green. Color the states you want to visit blue.



Firetruck

NAME: _____

Coloring

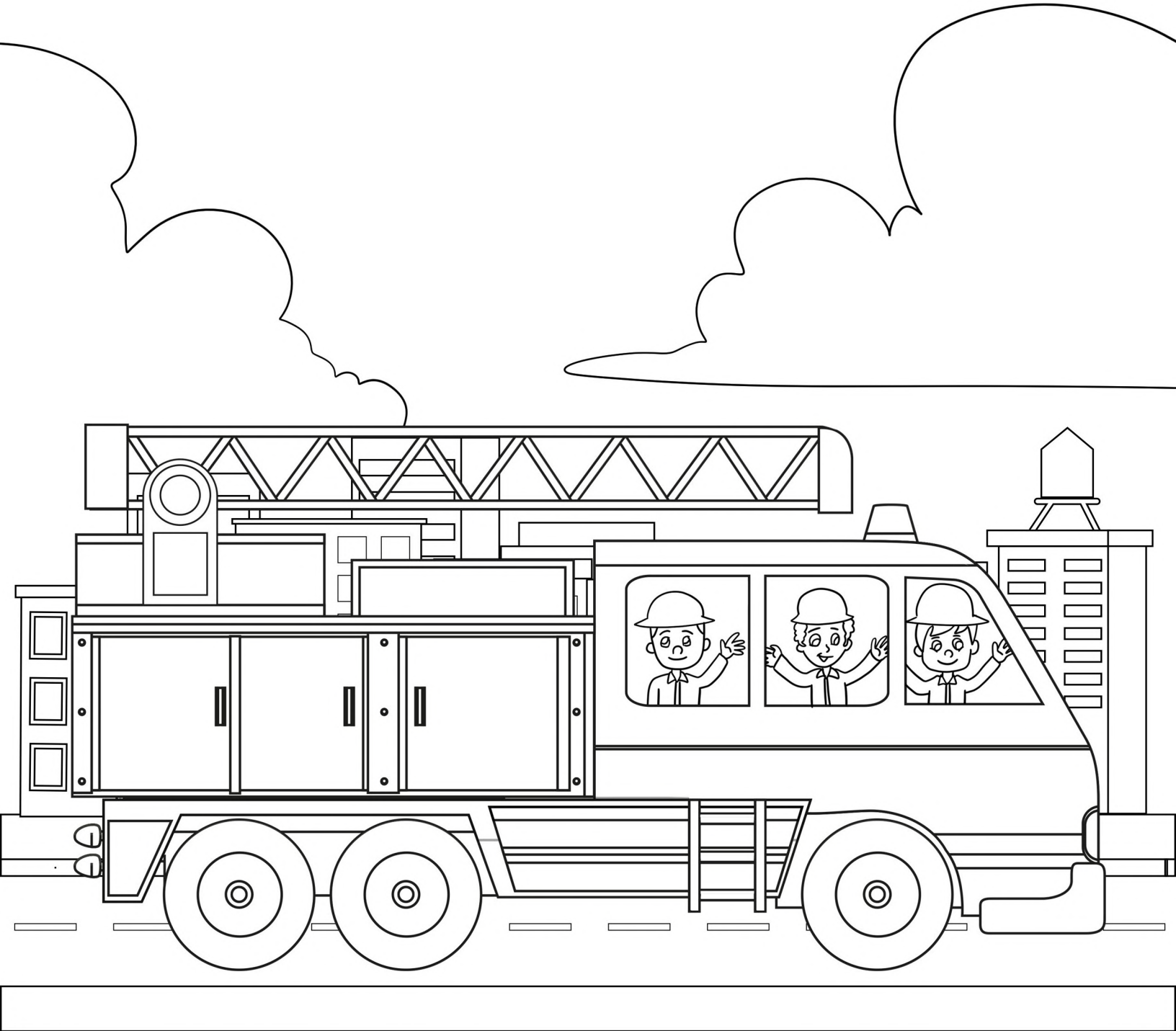

Firefighter

Five Little Penguins

NAME: _____

Math page. Addition practice.

$$\begin{array}{r} + 1 \\ 1 \\ \hline \end{array}$$

$$\begin{array}{r} + 1 \\ 2 \\ \hline \end{array}$$

$$\begin{array}{r} + 1 \\ 3 \\ \hline \end{array}$$

$$\begin{array}{r} + 1 \\ 4 \\ \hline \end{array}$$

$$\begin{array}{r} + 1 \\ 5 \\ \hline \end{array}$$

$$\begin{array}{r} + 2 \\ 1 \\ \hline \end{array}$$

$$\begin{array}{r} + 2 \\ 2 \\ \hline \end{array}$$

$$\begin{array}{r} + 2 \\ 3 \\ \hline \end{array}$$

$$\begin{array}{r} + 2 \\ 4 \\ \hline \end{array}$$

$$\begin{array}{r} + 2 \\ 5 \\ \hline \end{array}$$

$$\begin{array}{r} + 1 \\ 4 \\ \hline \end{array}$$

$$\begin{array}{r} + 2 \\ 3 \\ \hline \end{array}$$

$$\begin{array}{r} + 3 \\ 2 \\ \hline \end{array}$$

$$\begin{array}{r} + 4 \\ 1 \\ \hline \end{array}$$

$$\begin{array}{r} + 5 \\ 0 \\ \hline \end{array}$$

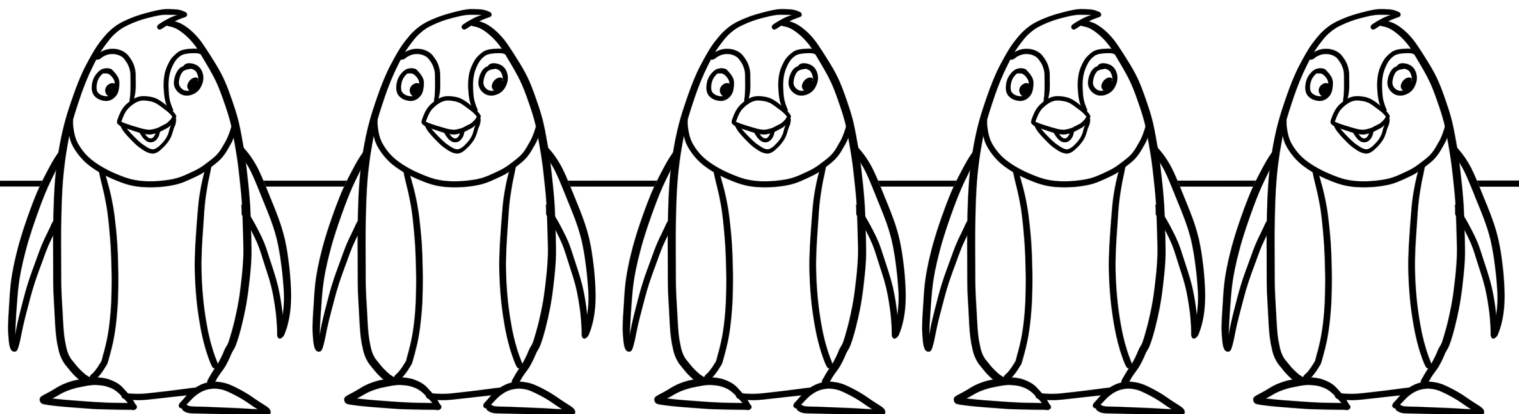

FL Blend Words

NAME: _____

Say the name of the picture. Fill in the letters that make the beginning sound.
Color the picture.

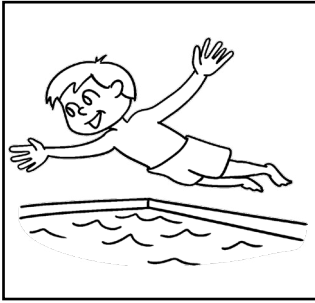

__ op

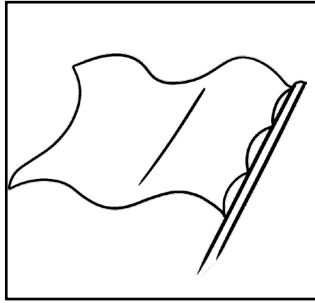

__ ag

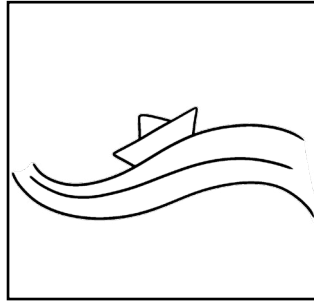

__ ow

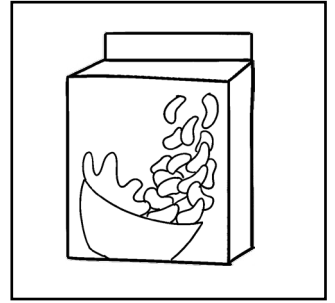

__ ake

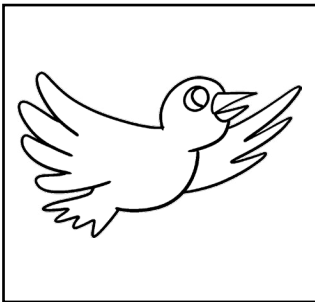

__ ew

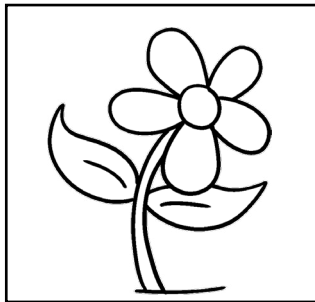

__ ower

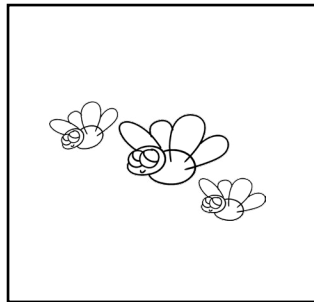

__ ies

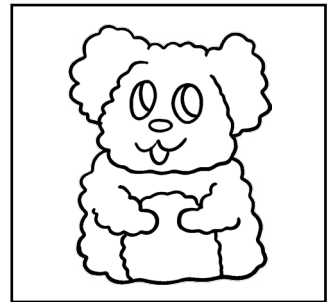

__ uff

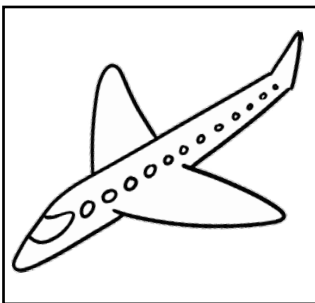

__ ight

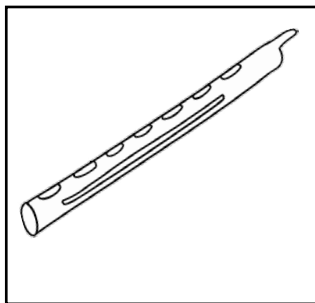

__ ute

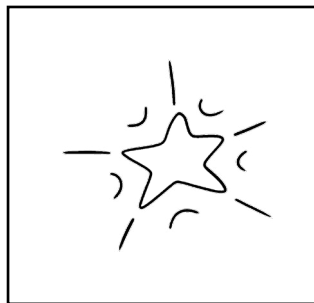

__ ash

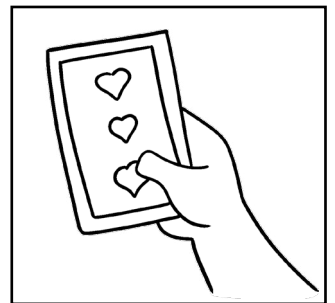

__ ip

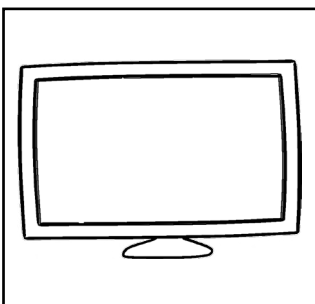

__ at

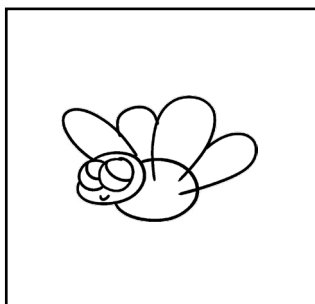

__ y

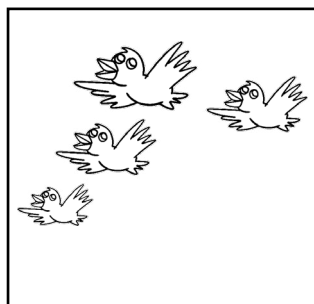

__ ock

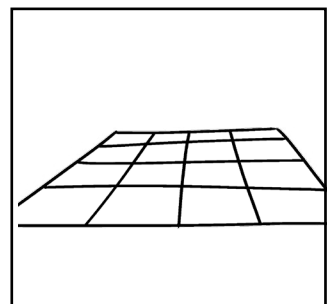

__ oor

Following the Rules

NAME: _____

Cut and paste the classroom rules under each image

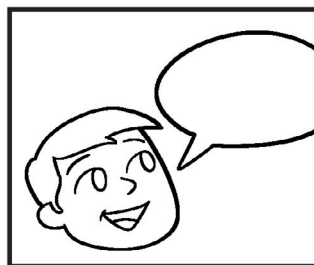
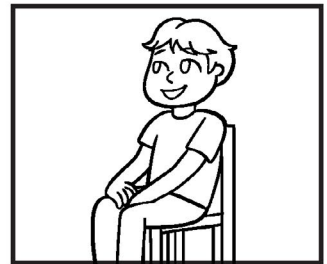
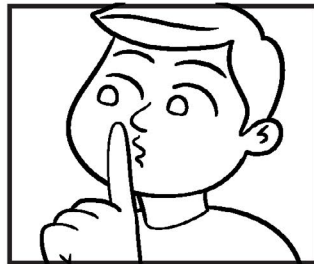
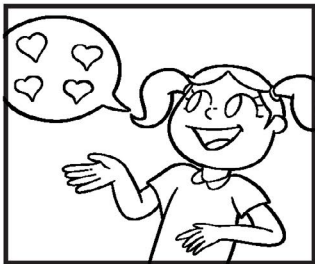
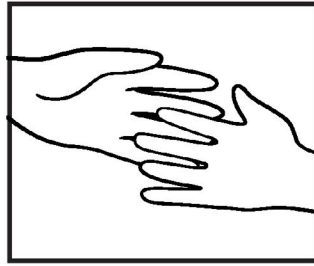
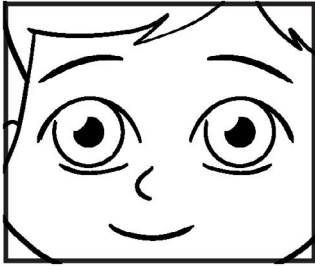

Raise your hand to be called on	Kind word	Sit in your seat	Ears listening	Feet walking
Hands helping	Voices are quiet	Eyes watching	Polite words	Take turns sharing

FR Blend Words

NAME: _____

Say the name of the picture. Fill in the letters that make the beginning sound.
Color the picture.

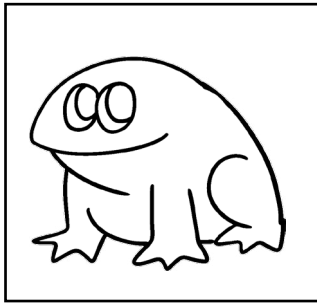

__og

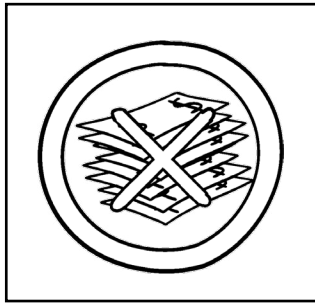

__ee

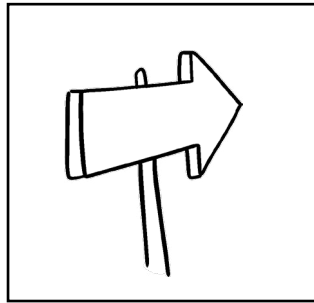

__om



__eeze

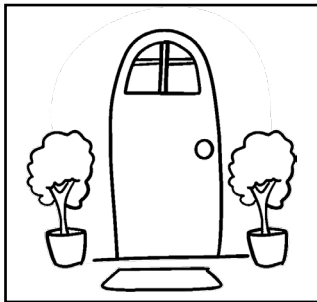

__ont



__ost

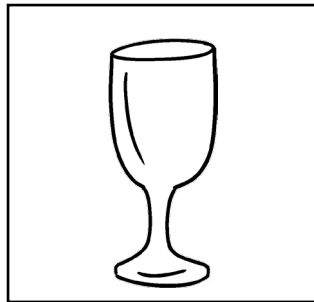

__ail

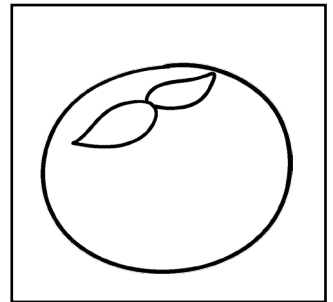

__esh



__own

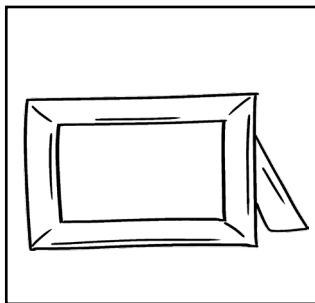

__ame

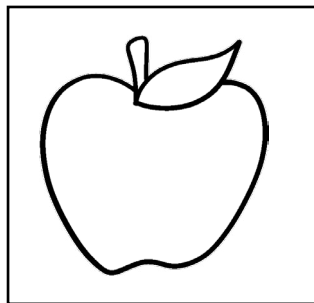

__uit

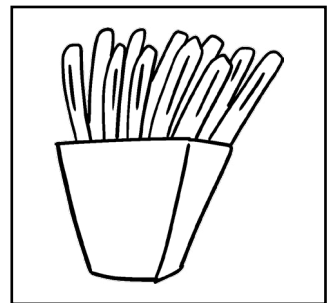

__ied

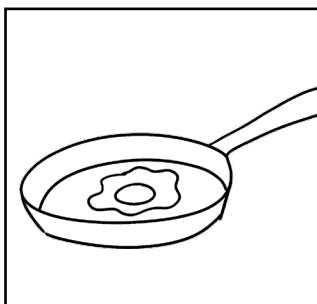

__y

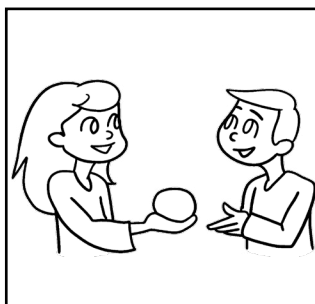

__iend

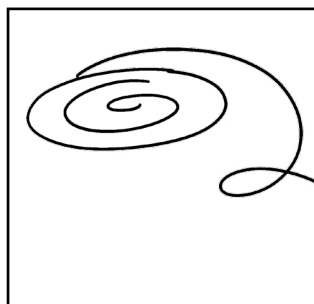

__isbee

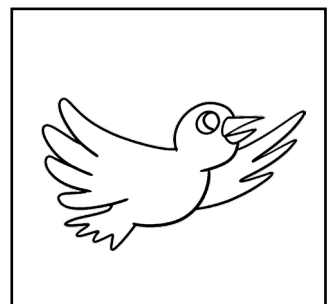

__eedom

Germs

NAME: _____

Here are some things we can do to stay healthy. Color the pictures and trace the words.

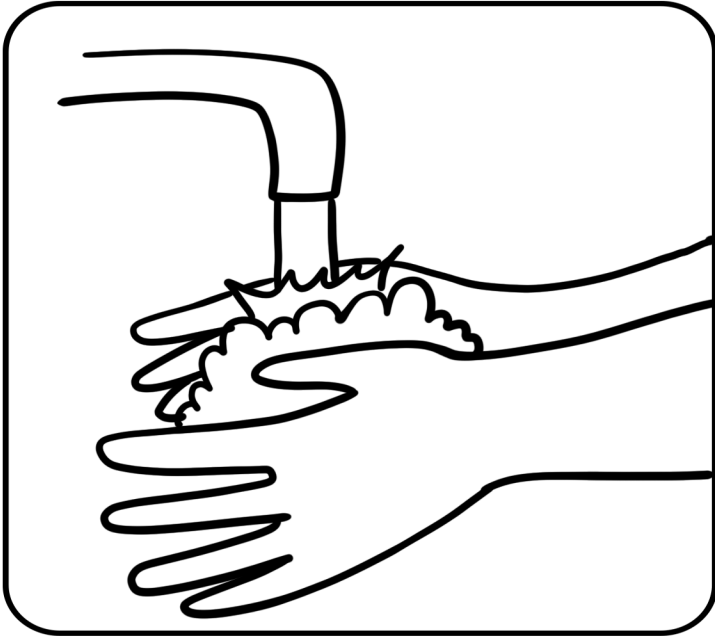

Wash hands



Don't touch face

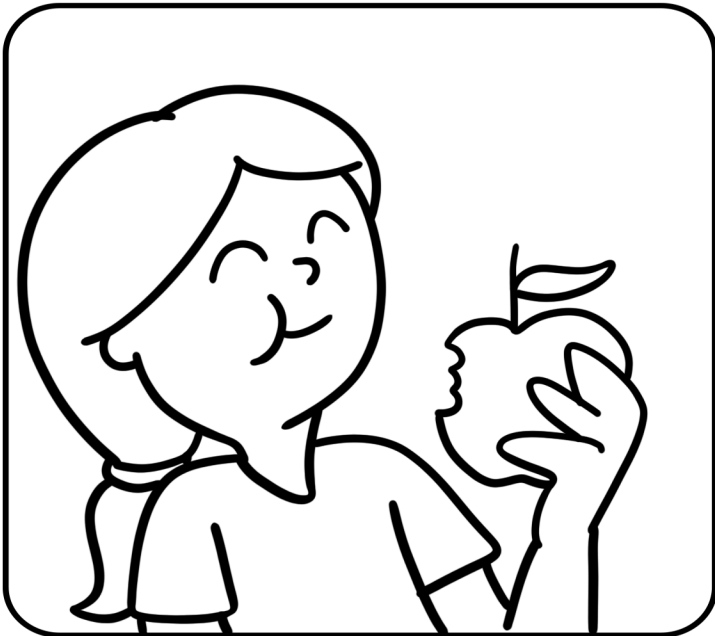

Eat healthy



Sleep well

GL Blend Words

NAME: _____

Say the name of the picture. Fill in the letters that make the beginning sound.
Color the picture.

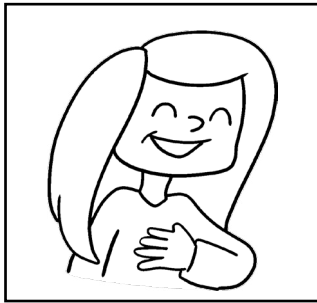

__ad

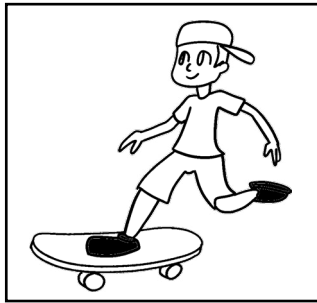

__ide

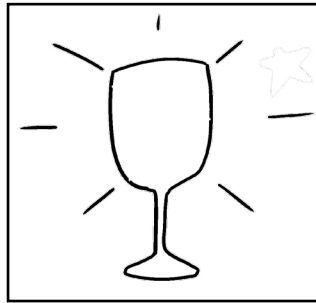

__oss

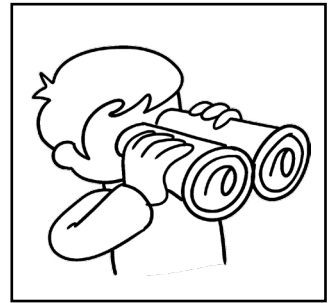

__ance

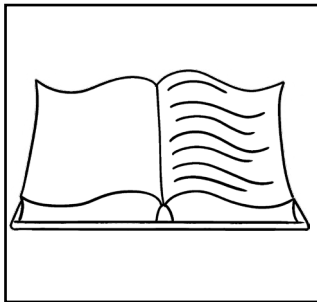

__ossary

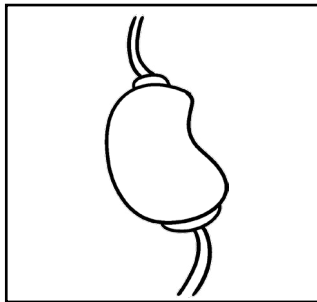

__and

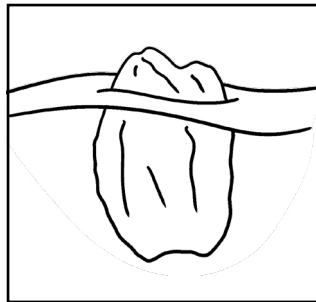

__acier

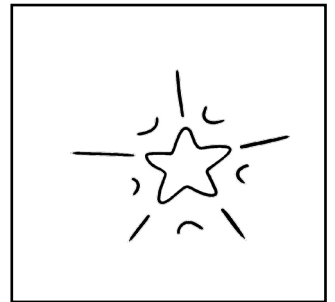

__are

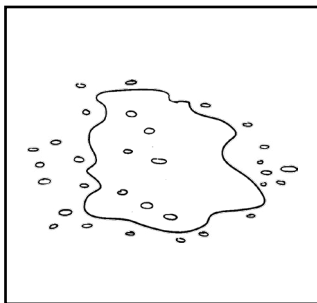

__itter

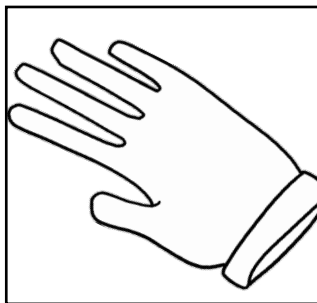

__ove

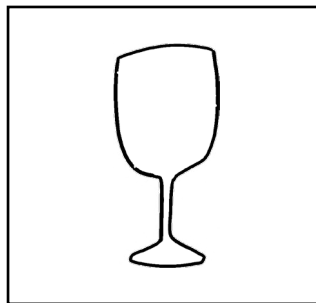

__ass

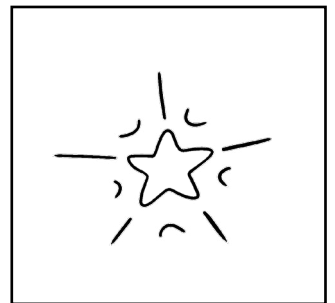

__ow



__eam

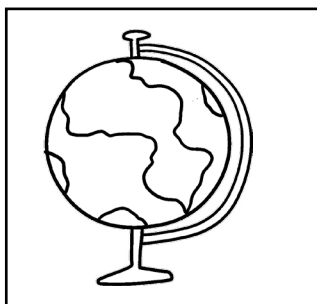

__obe

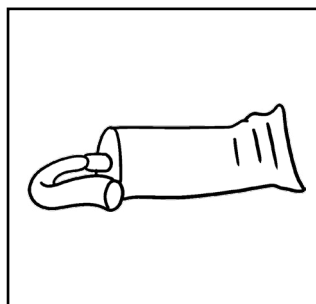

__ue

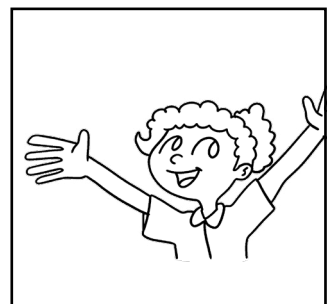

__ee

Going on a Trip

NAME: _____

Find the animals. Circle the rabbit, the bird, the nest with little birds, the mouse, and the bull.

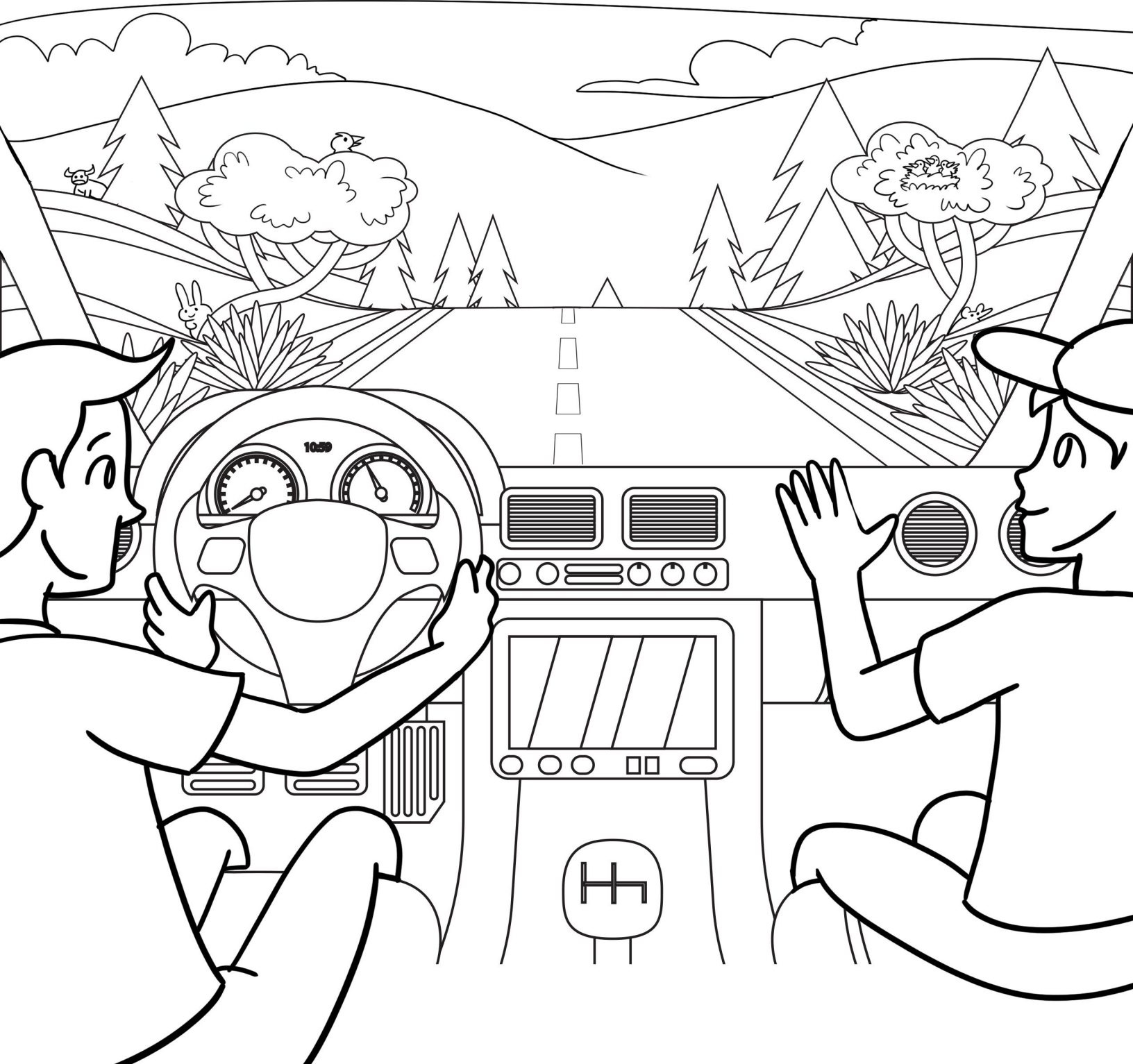

GR Blend Words

NAME: _____

Say the name of the picture. Fill in the letters that make the beginning sound.
Color the picture.

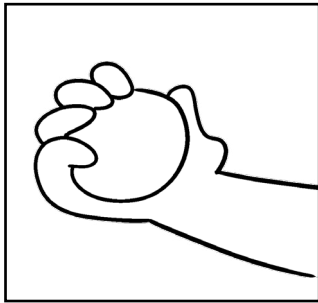

__ab

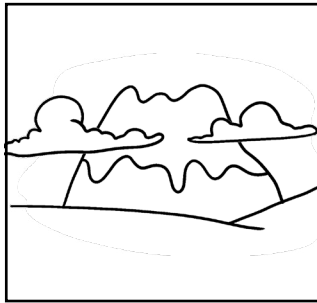

__eat

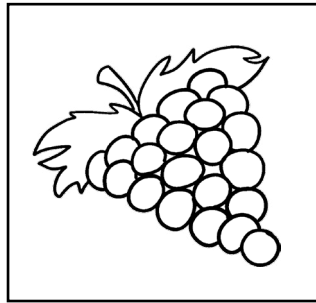

__ape

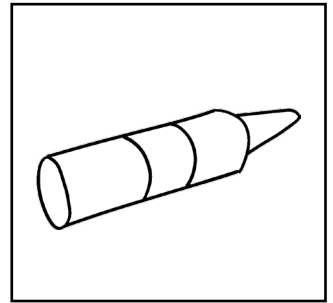

__een

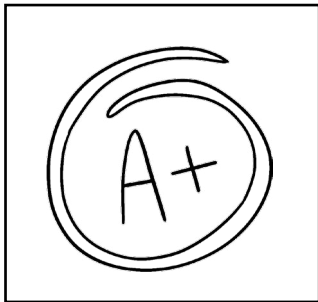

__ade

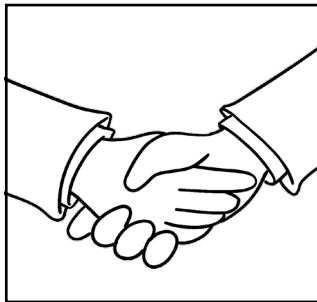

__eet

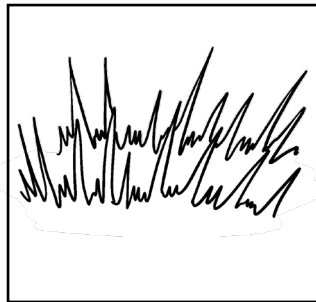

__ass

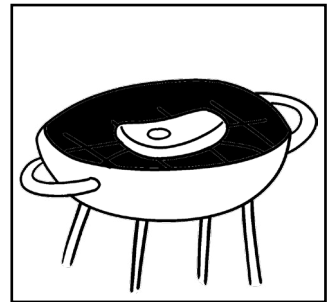

__ill

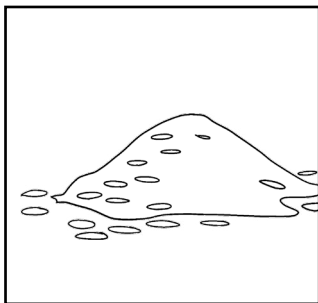

__ain

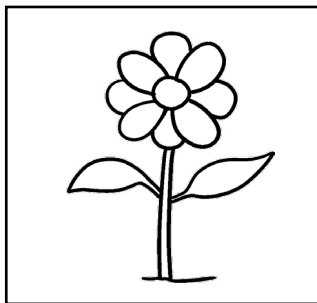

__ow

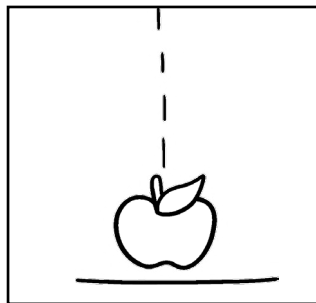

__avity

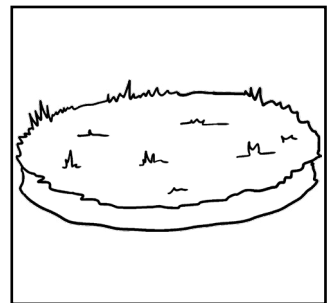

__ound

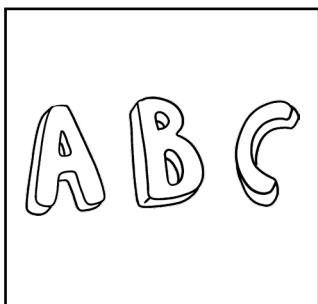

__ammar

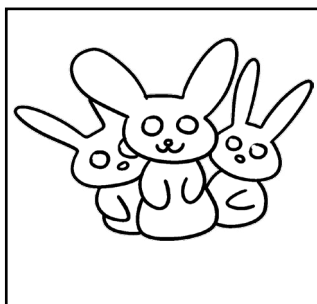

__oup

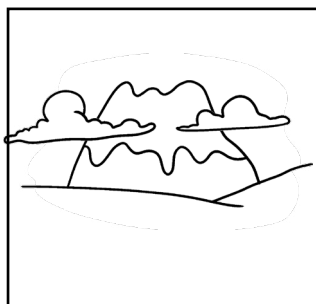

__and

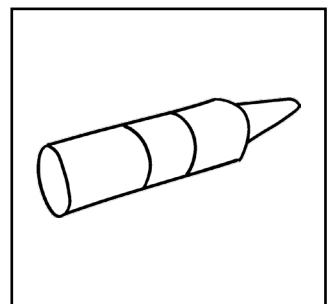

__ay

Hand Jive

NAME: _____

Can you name the different fingers?

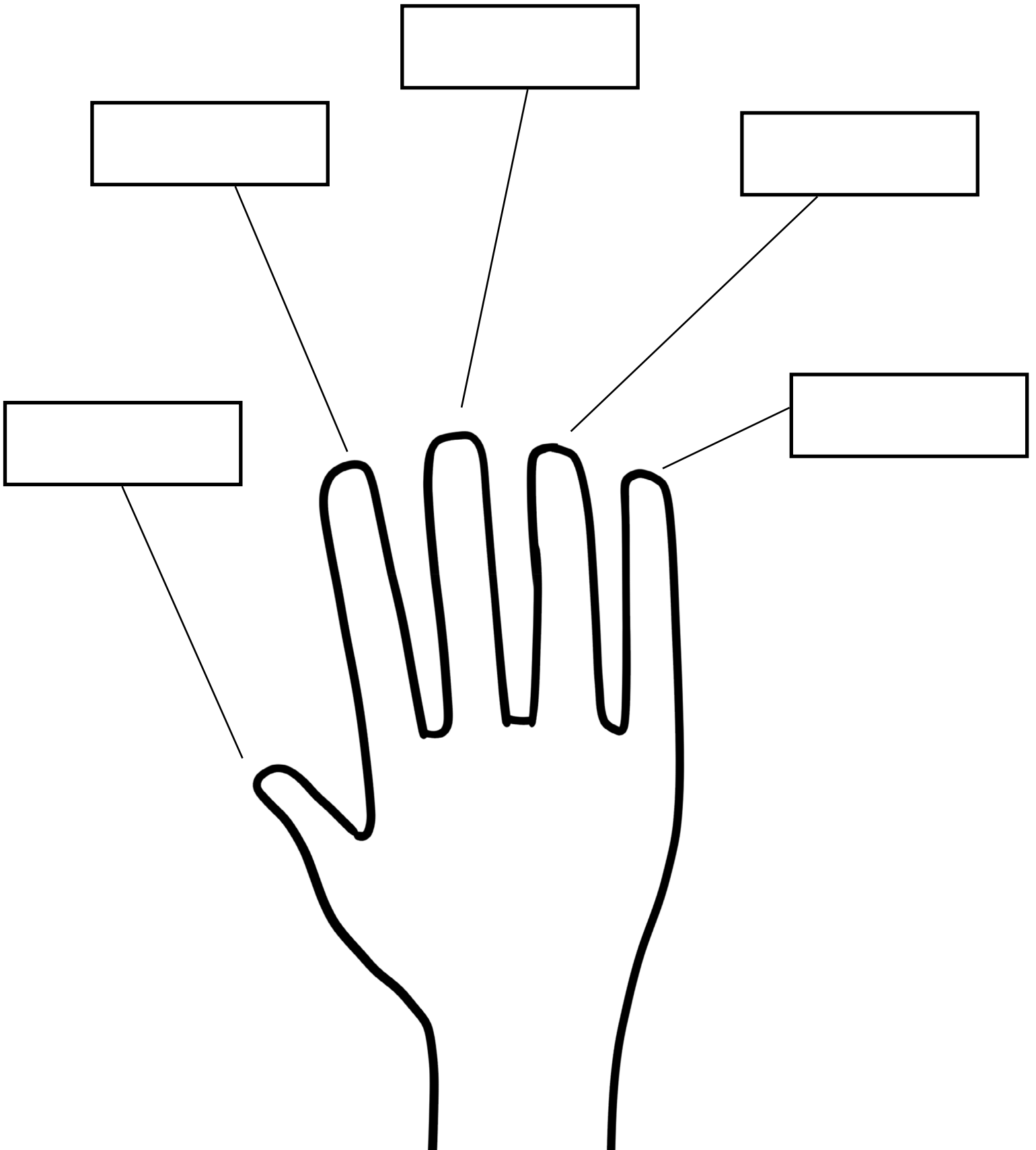

Hi Shadow

NAME: _____

Coloring.

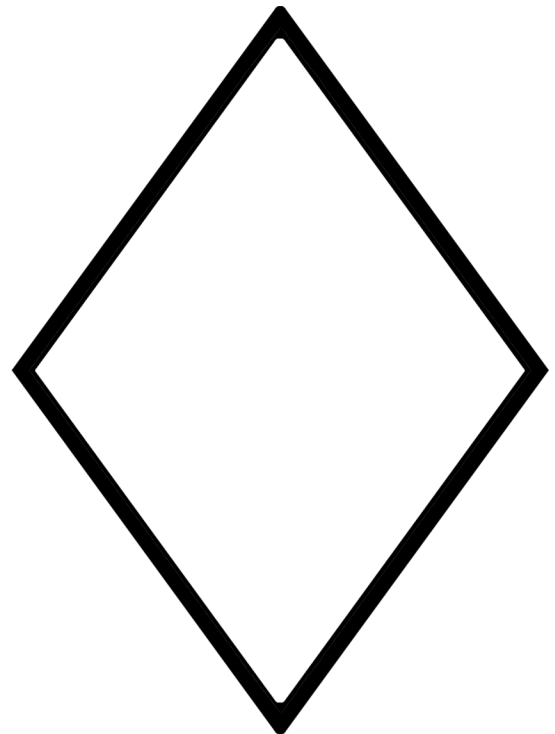
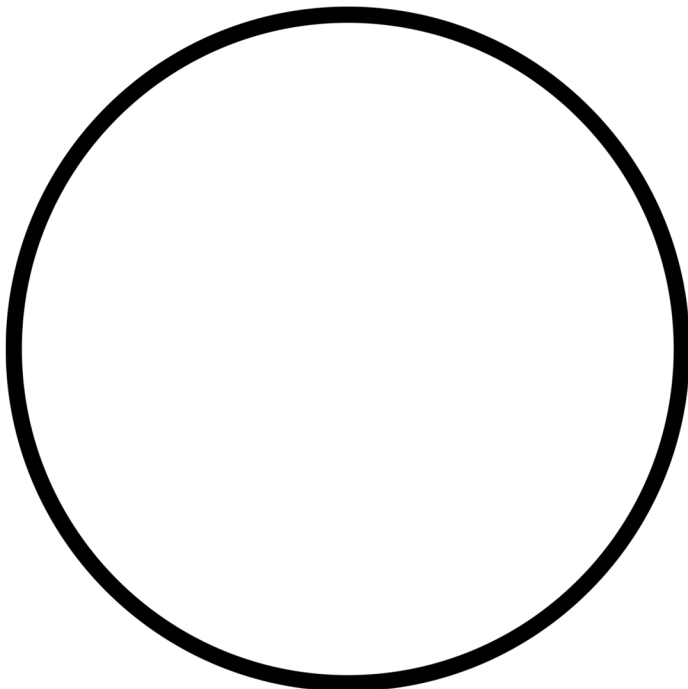
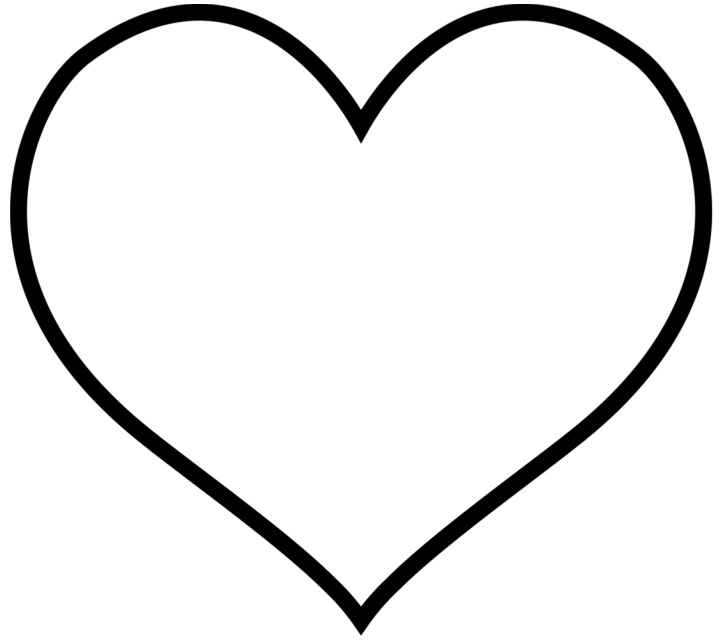
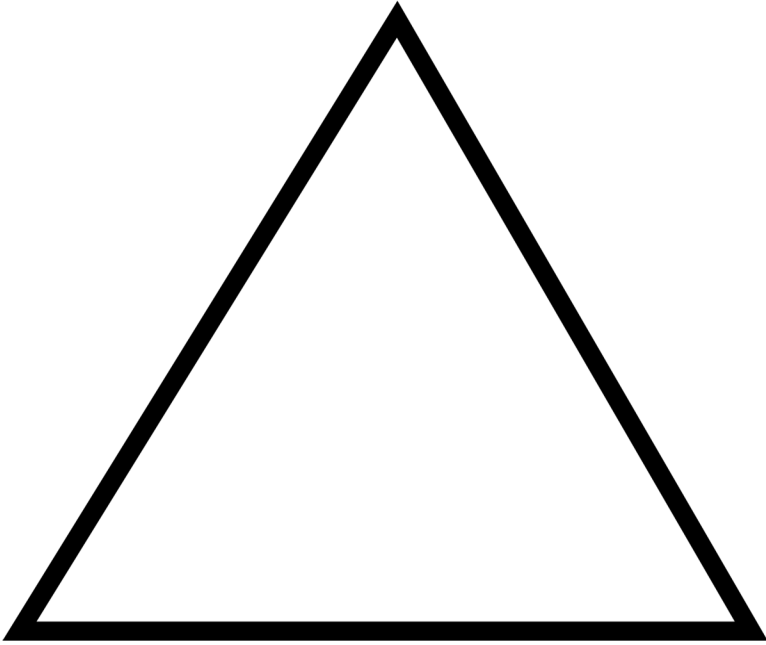

I Can Tango

NAME: _____

Add the number of foot steps in each row. Write the answer in the space given.

$$\begin{array}{ccc} \begin{array}{c} \text{1 foot step} \\ \text{1} \\ \hline \end{array} & + & \begin{array}{c} \text{1 foot step} \\ \text{1} \\ \hline \end{array} & = & \underline{\hspace{2cm}} \end{array}$$

$$\begin{array}{ccc} \begin{array}{c} \text{2 foot steps} \\ \text{2} \\ \hline \end{array} & + & \begin{array}{c} \text{2 foot steps} \\ \text{2} \\ \hline \end{array} & = & \underline{\hspace{2cm}} \end{array}$$

$$\begin{array}{ccc} \begin{array}{c} \text{3 foot steps} \\ \text{3} \\ \hline \end{array} & + & \begin{array}{c} \text{2 foot steps} \\ \text{2} \\ \hline \end{array} & = & \underline{\hspace{2cm}} \end{array}$$

$$\begin{array}{ccc} \begin{array}{c} \text{2 foot steps} \\ \text{2} \\ \hline \end{array} & + & \begin{array}{c} \text{4 foot steps} \\ \text{4} \\ \hline \end{array} & = & \underline{\hspace{2cm}} \end{array}$$

$$\begin{array}{ccc} \begin{array}{c} \text{4 foot steps} \\ \text{4} \\ \hline \end{array} & + & \begin{array}{c} \text{3 foot steps} \\ \text{3} \\ \hline \end{array} & = & \underline{\hspace{2cm}} \end{array}$$

I Like to Dance

NAME: _____

Circle all right hands and feet in red. Circle all left hands and feet in blue.

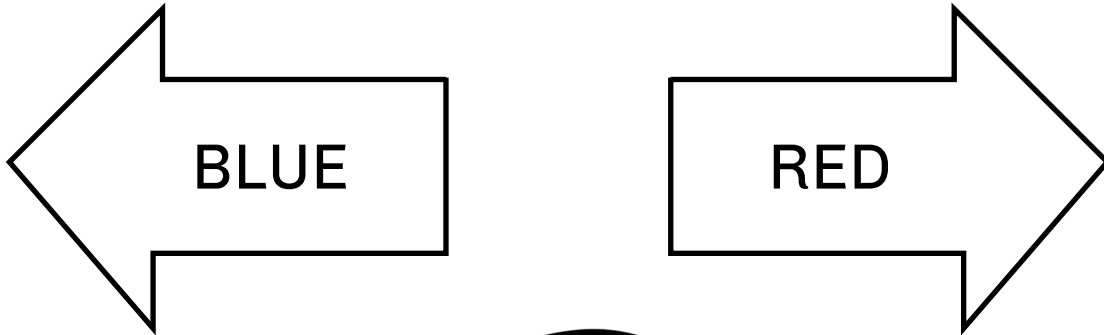

If I Were an Animal

NAME: _____

Coloring



I'm A Fish

NAME: _____

Coloring

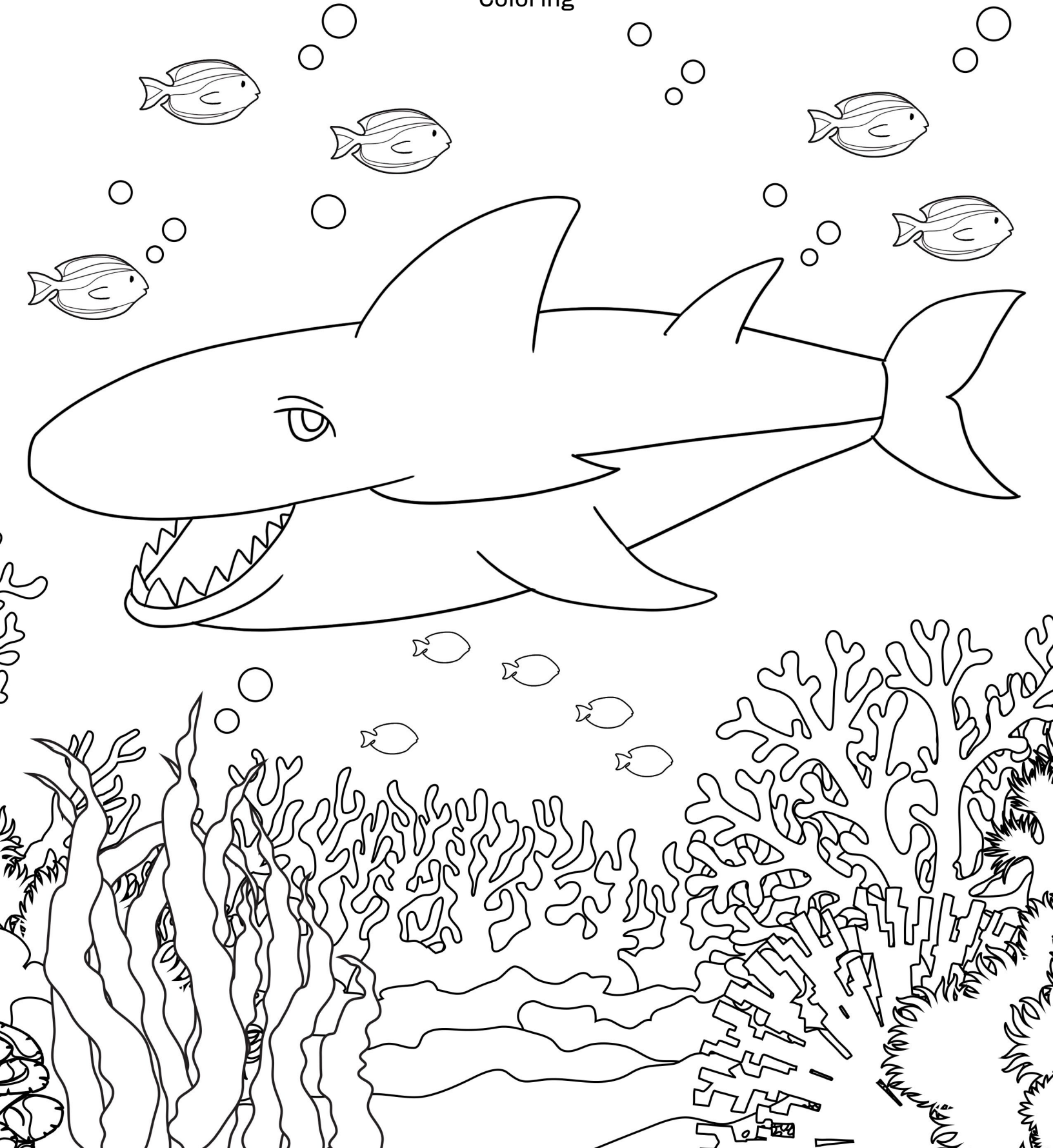

Jack O Lantern

NAME: _____

Coloring



Jack-O-Lantern

Just the Way I Am

NAME: _____

Write the name of the body parts

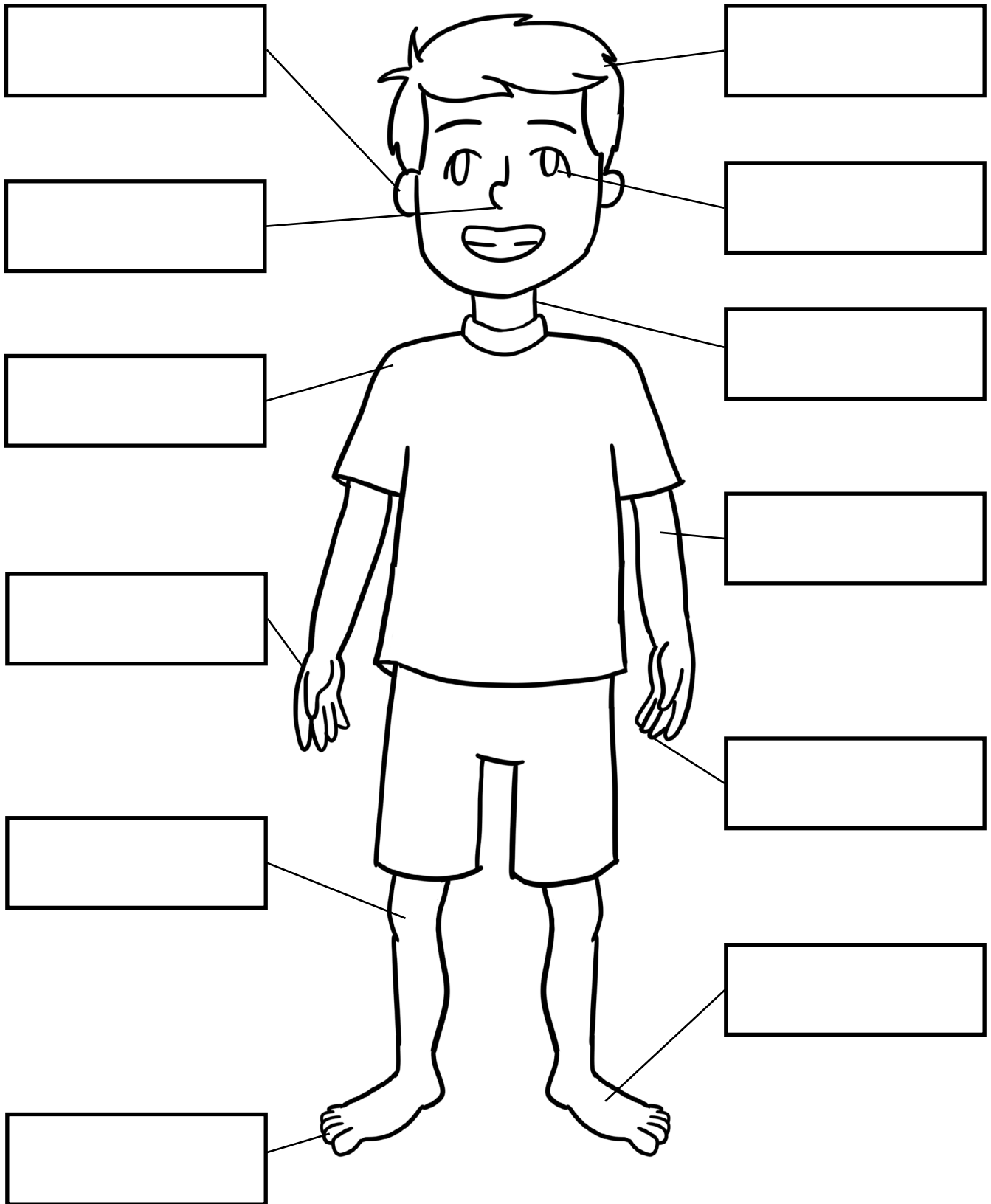

KN Blend Words

NAME: _____

Say the name of the picture. Fill in the letters that make the beginning sound.
Color the picture.

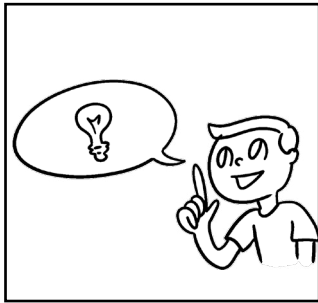

__ow

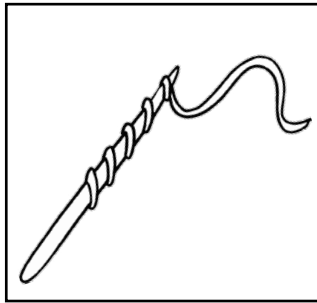

__it

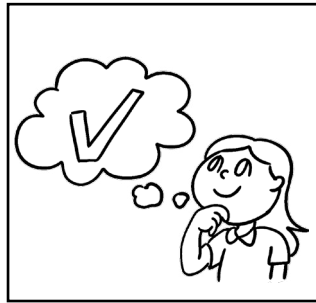

__ew

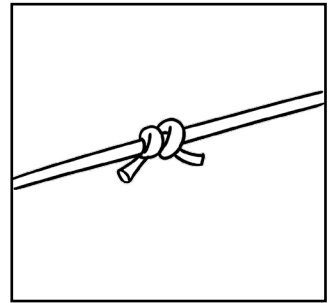

__ot

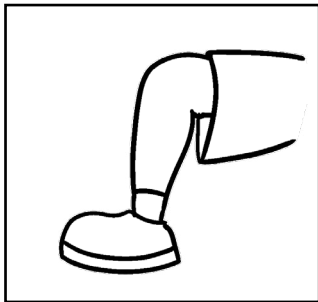

__ee

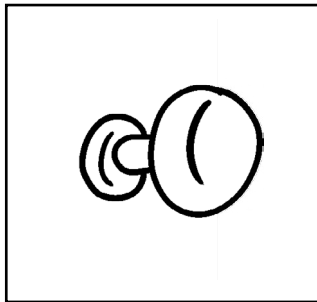

__ob



__ed

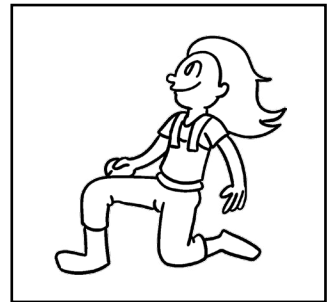

__eel

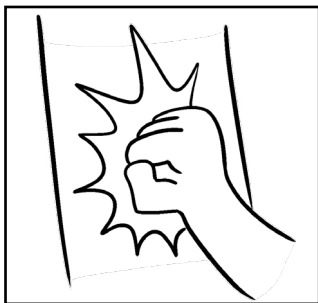

__ock

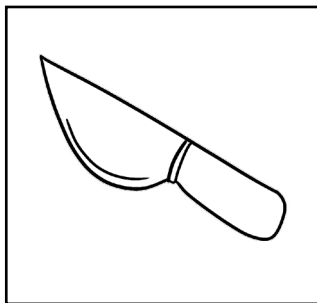

__ife

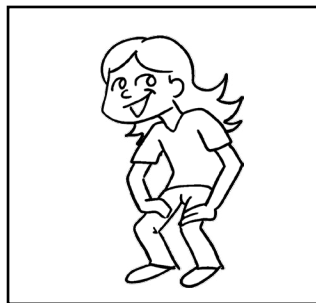

__elt

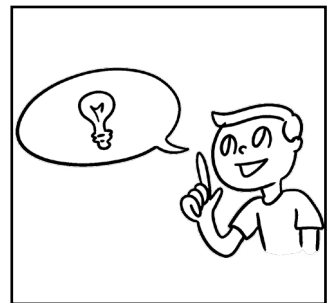

__own

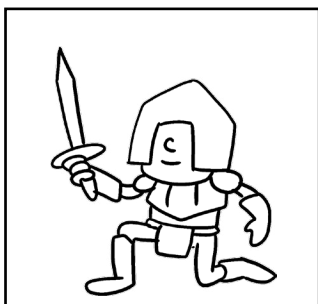

__ights

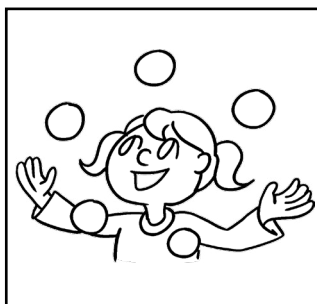

__ack

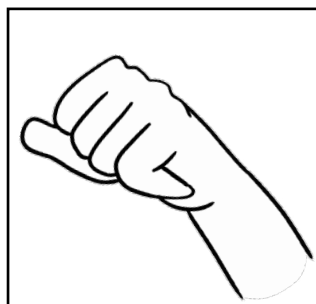

__uckle

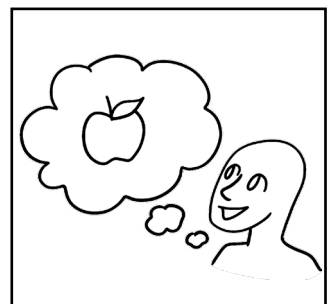

__owledge

Mommy and Me

NAME: _____

Fill in the blank spaces

My Mom is special to me because

_____ ,

My Mom is the best at _____ ,

My favorite thing to do with

my mom is _____ ,

I love my Mom's _____ .



**My Very
Special
Mom**



Mommy's Got a Baby in Her Belly

NAME: _____

Coloring



Money

NAME: _____

Add the number of coins in each row and write the answer in the space given.



+



=

1¢

+

5¢

=



+



=

10¢

+

25¢

=



+



=

25¢

+

10¢

=



+



=

11¢

+

7¢

=

Parachute

NAME: _____

Color all the circles blue, the triangles red and the squares green.

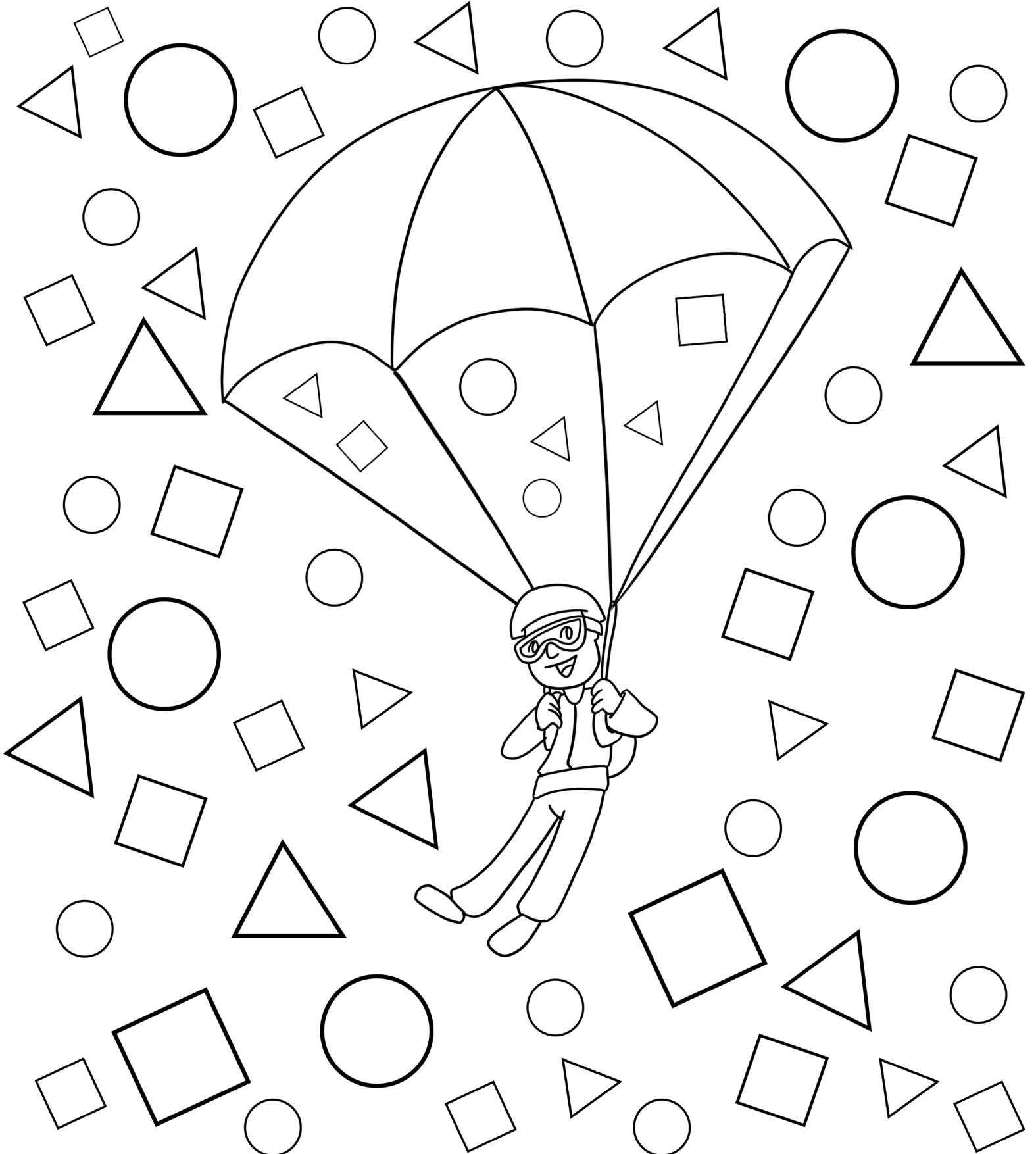

Phonics Alphabet

NAME: _____

Practice writing. Trace the alphabet

Aa Bb Cc Dd

Ee Ff Gg Hh

Ii Jj Kk Ll

Mm Nn Oo Pp

Qq Rr Ss Tt

Uu Vv Ww Xx

Yy Zz

Pick Up and Put it Away

NAME: _____

Color by number. 1=white, 2=yellow, 3=orange, 4=red, 5=brown, 6=black, 7=purple, 8=blue, 9= sky blue, 10=green.

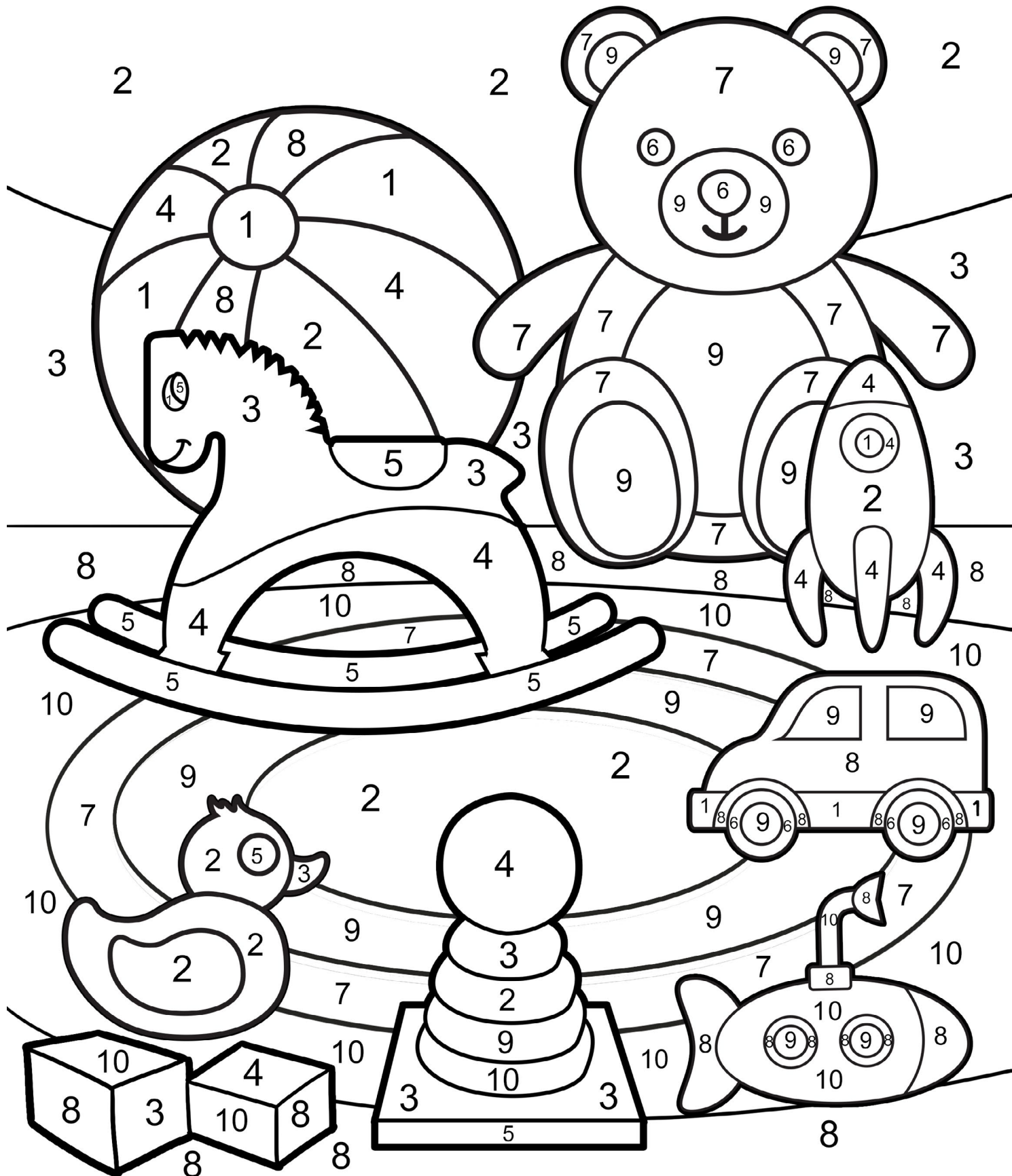

PL Blend Words

NAME: _____

Say the name of the picture. Fill in the letters that make the beginning sound.
Color the picture.

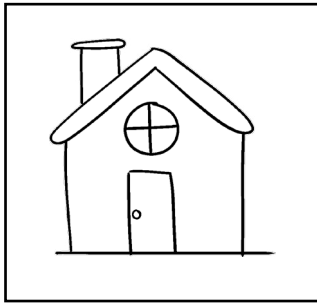

__ace

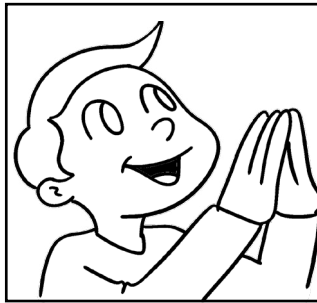

__ease

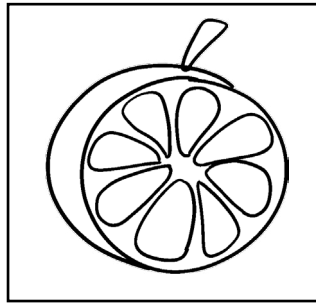

__ump

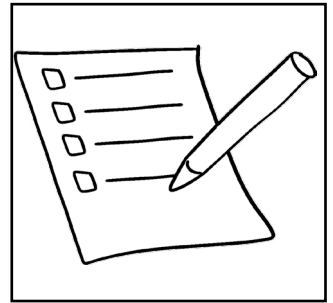

__an

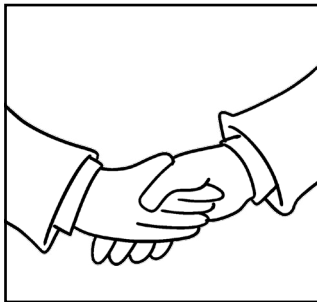

__edge

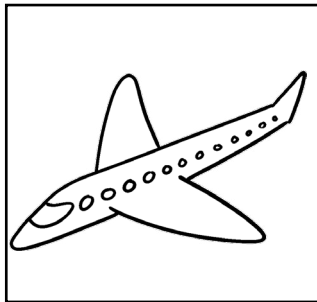

__ane

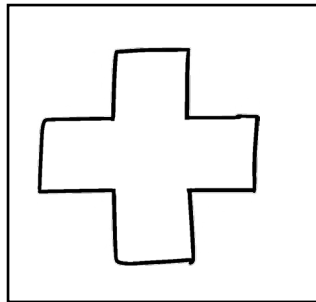

__us

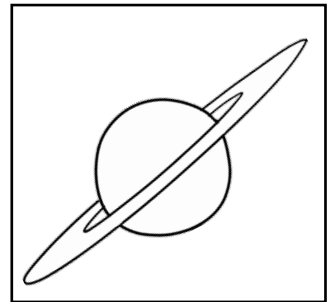

__anet

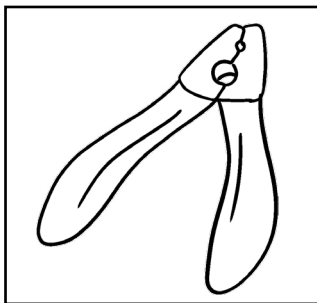

__iers

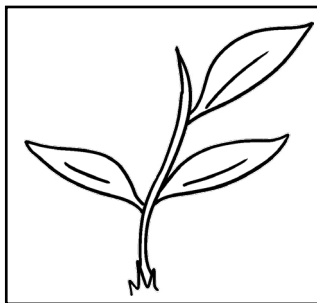

__ant



__ot

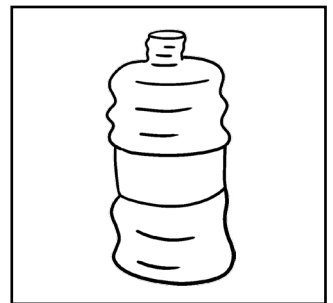

__astic

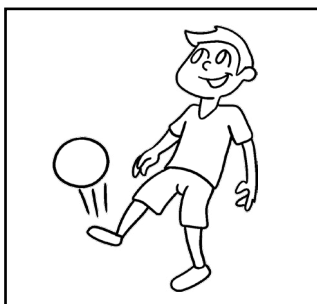

__ay

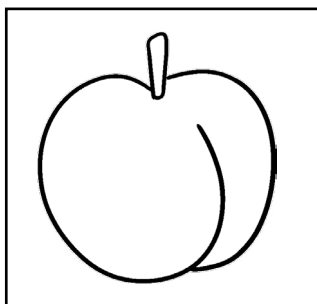

__um

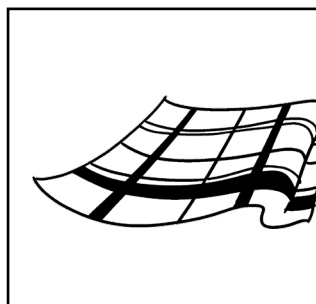

__aid

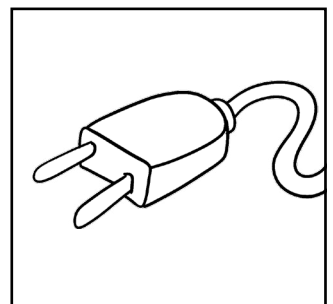

__ug

Pop the Bubbles

NAME: _____

Fill in the missing numbers. 1 to 20.

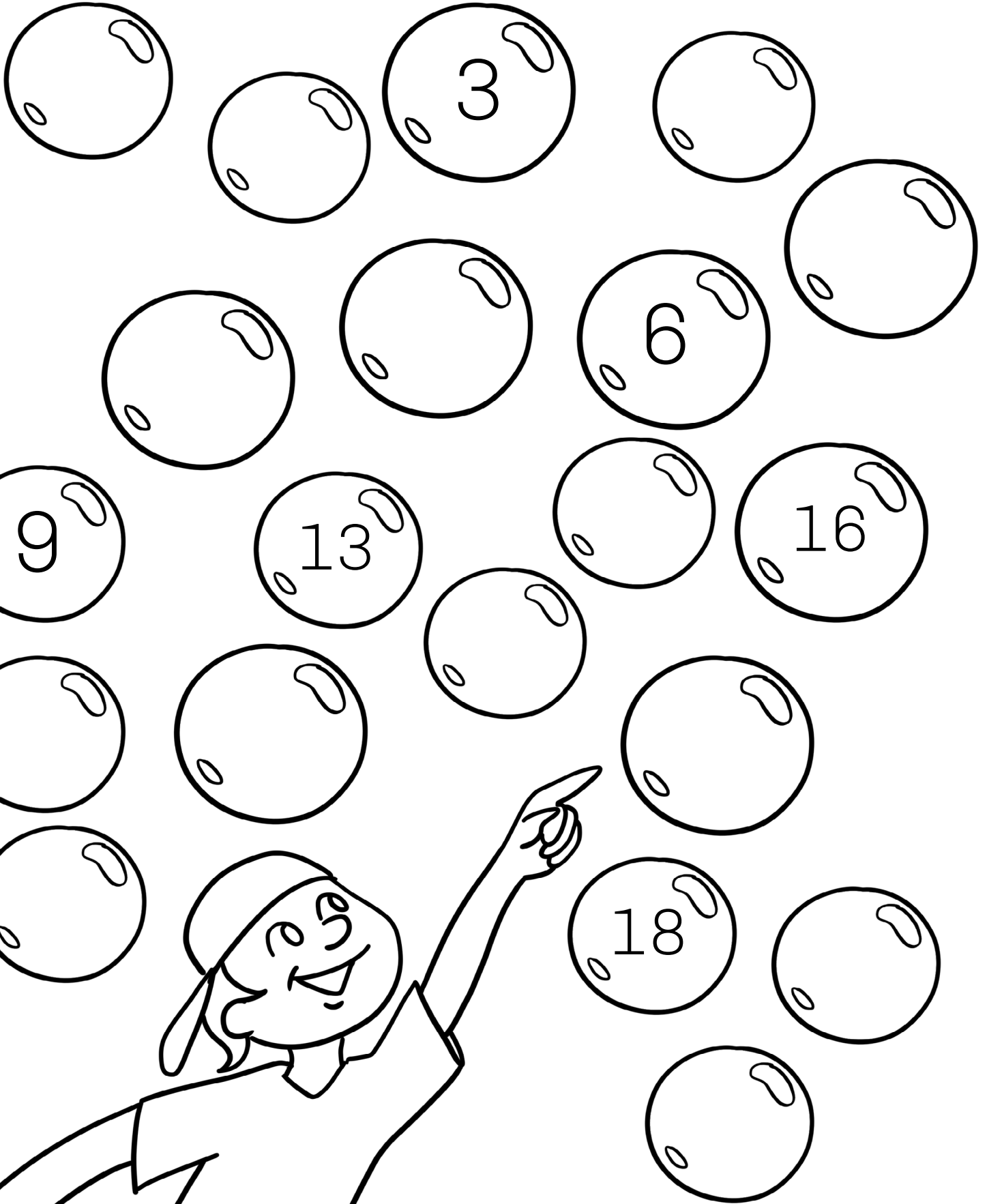

Potty Time

NAME: _____

Coloring

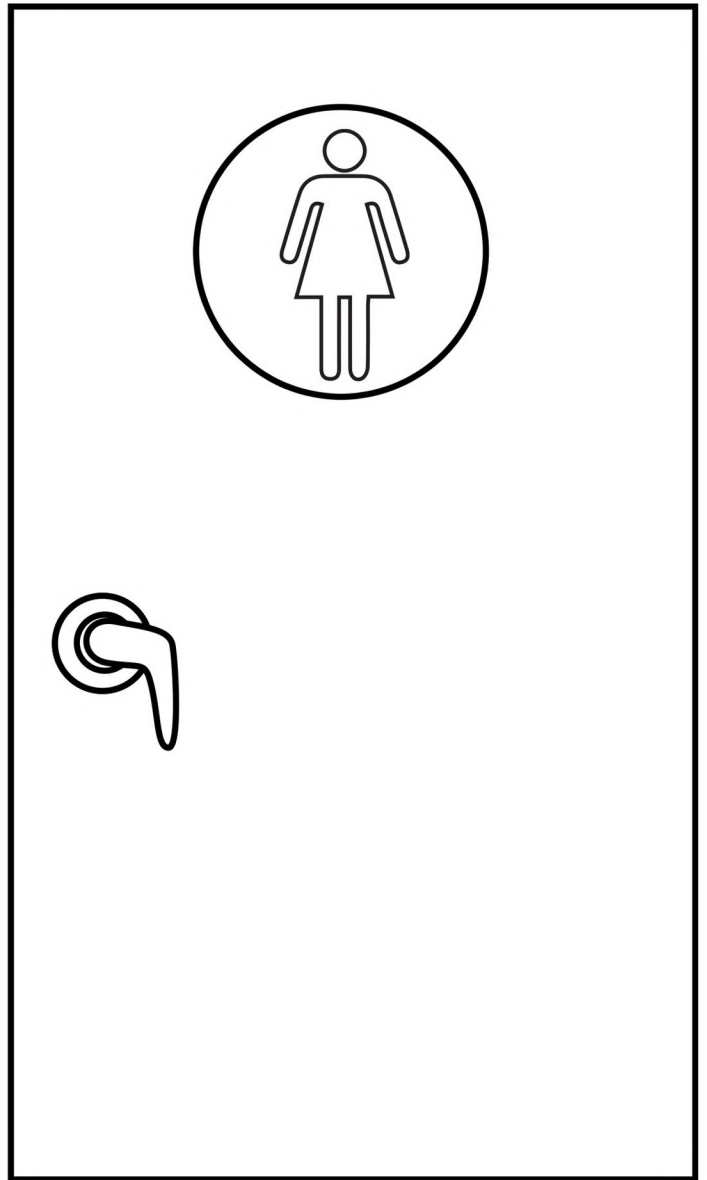
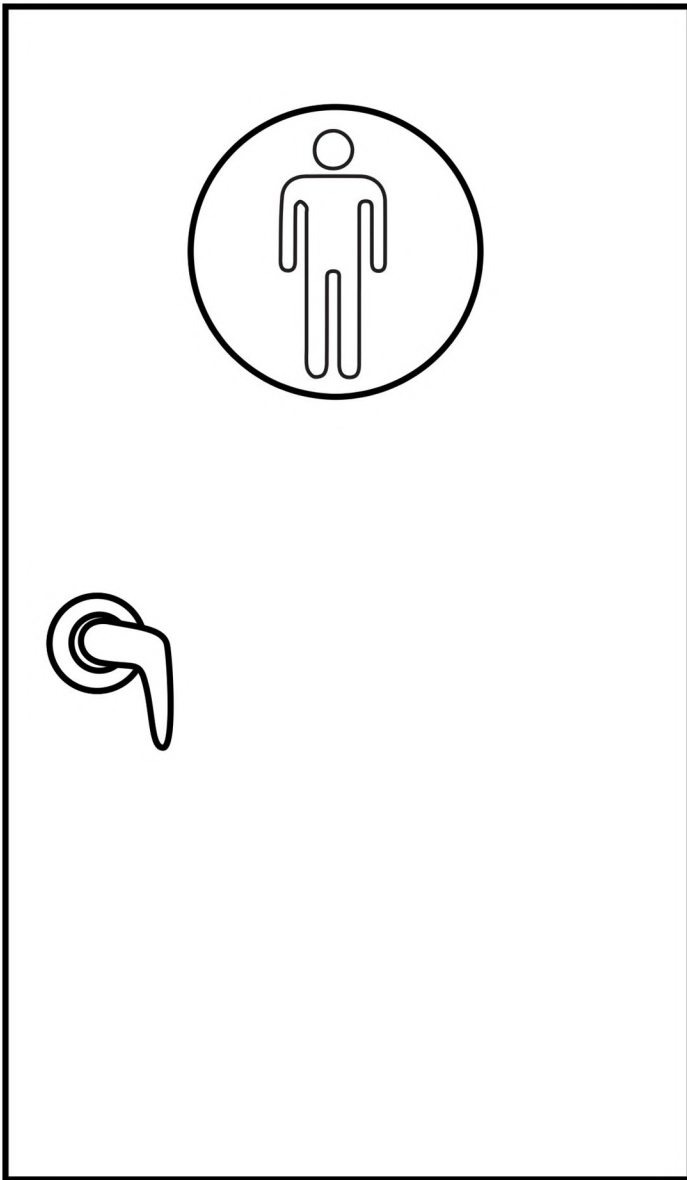

PR Blend Words

NAME: _____

Say the name of the picture. Fill in the letters that make the beginning sound.
Color the picture.

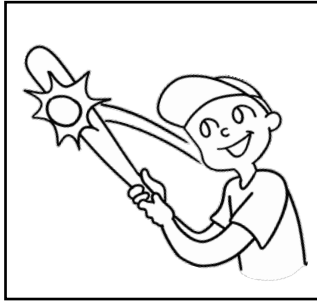

__actice

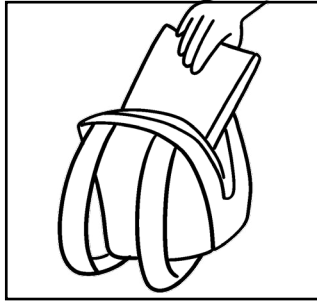

__epare

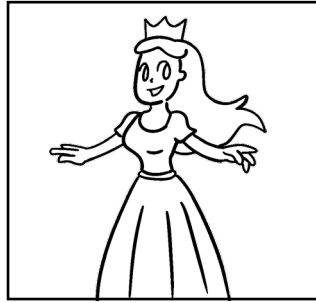

__incess

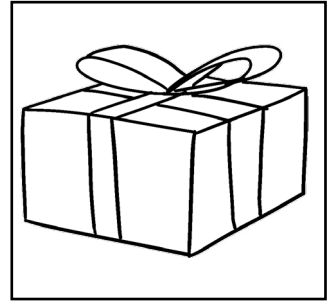

__esent

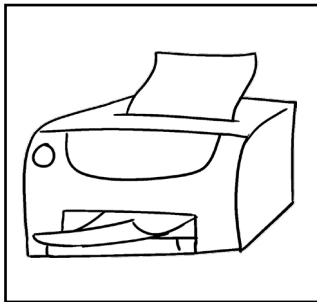

__int

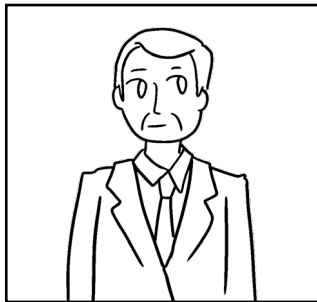

__esident

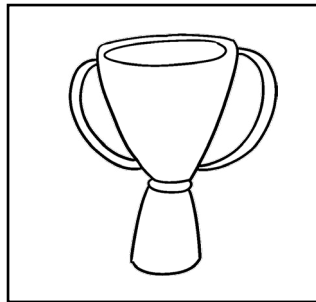

__ize

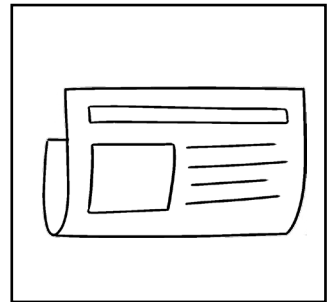

__ess

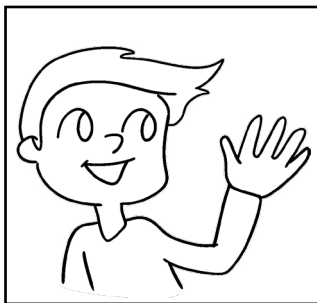

__etend

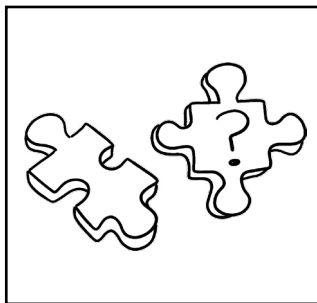

__oblem

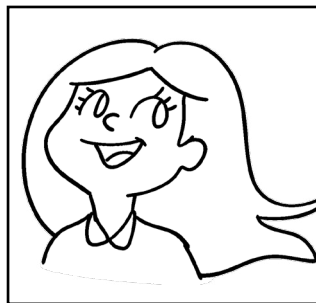

__etty

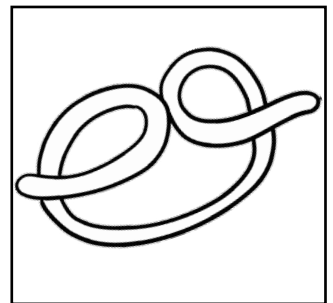

__etzel

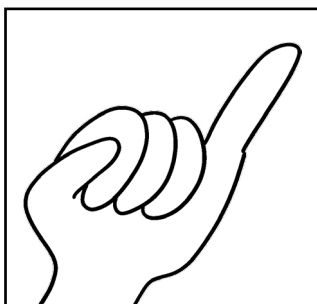

__omise

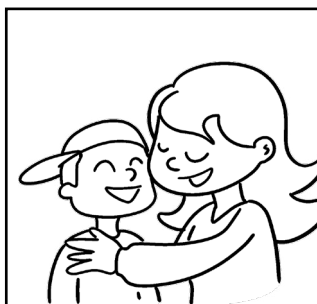

__oud



__edict

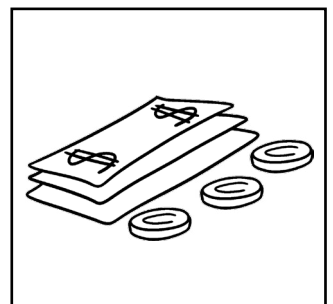

__ice

QU Blend Words

NAME: _____

Say the name of the picture. Fill in the letters that make the beginning sound.
Color the picture.

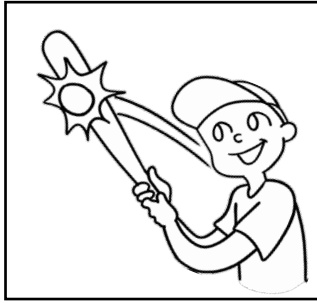

__ ick

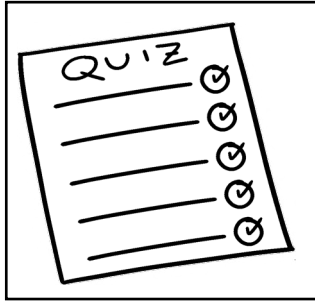

__ iz

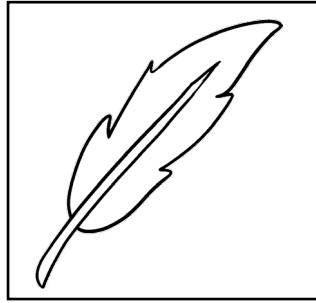

__ ill

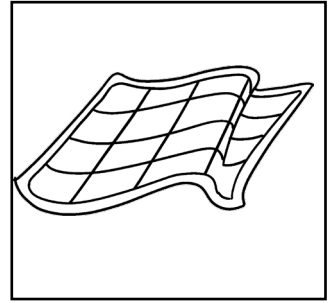

__ ilt

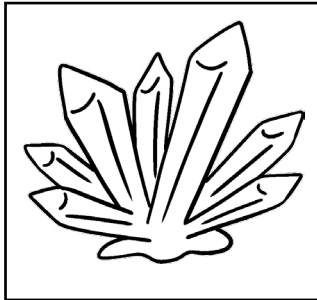

__ artz

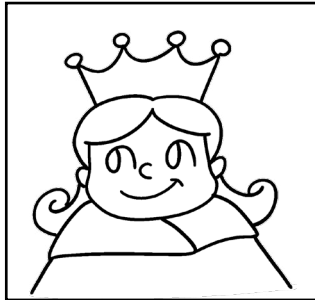

__ een

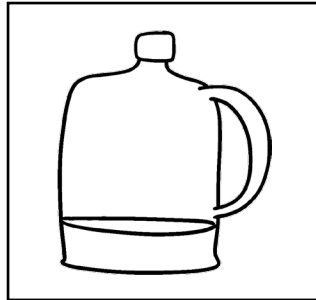

__ art

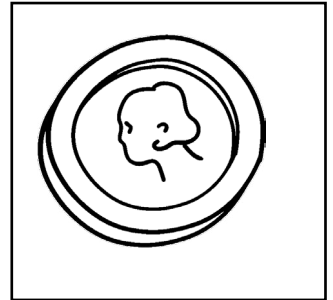

__ arter



__ iet

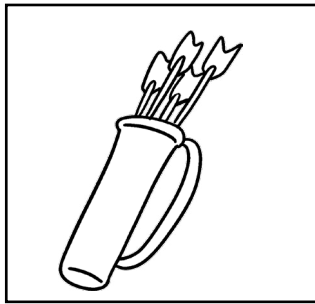

__ iver



__ ote

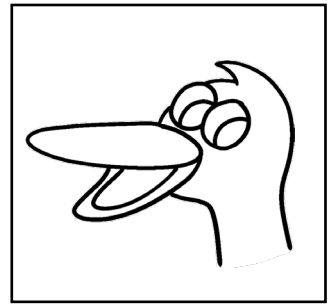

__ ack

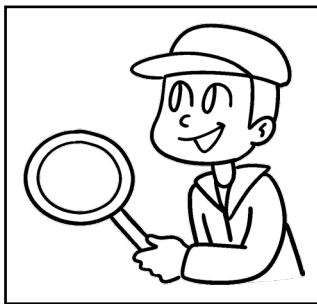

__ est

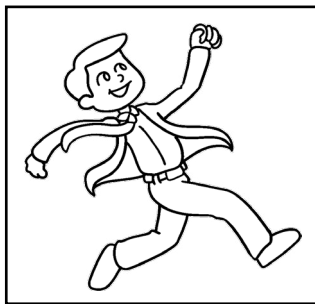

__ it

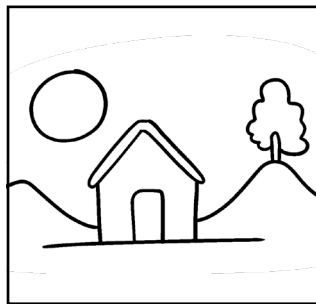

__ aint



__ estion

Reduce, Reuse and Recycle

NAME: _____

Circle the items that you can recycle.



Riding My Bicycle

NAME: _____

Crossword puzzle.

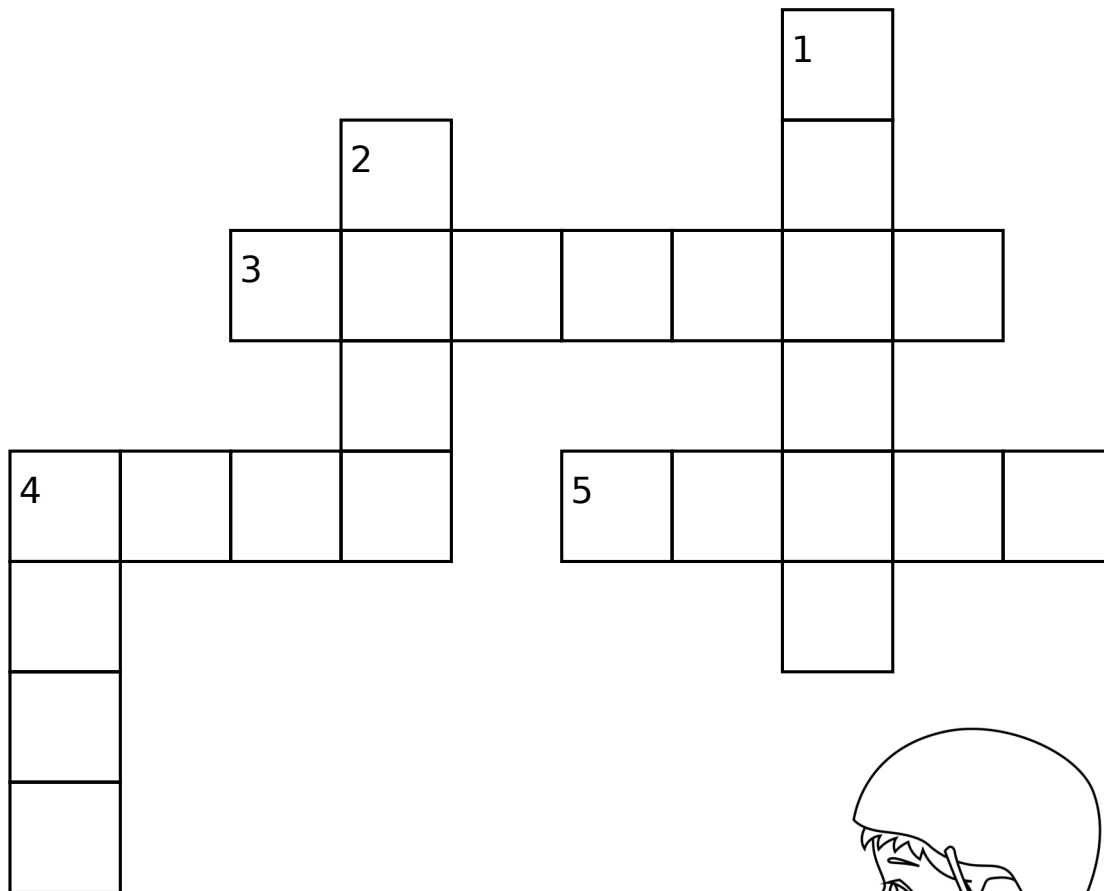

Down:

1. Serves to protect the head
2. Also know as bicycle
4. A wide way leading from one place to another

Across:

3. It has two wheels
4. Sit on and control the movement of ta bike
5. It has a circle shape



SC Blend Words

NAME: _____

Say the name of the picture. Fill in the letters that make the beginning sound.
Color the picture.



__ale

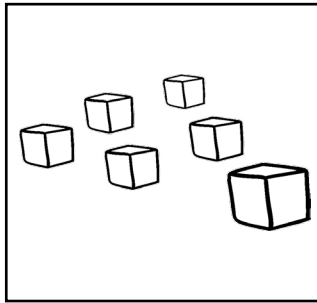

__atter

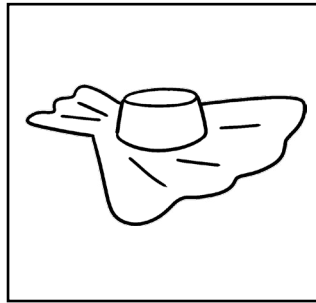

__allop

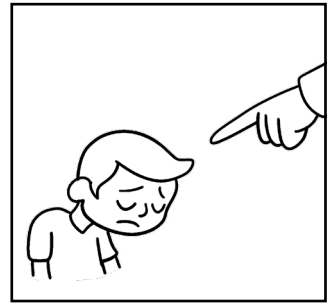

__old



__alp

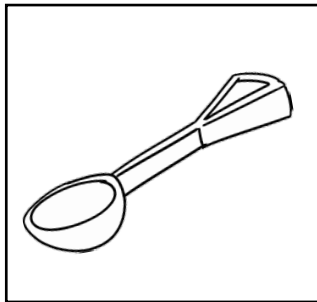

__oop

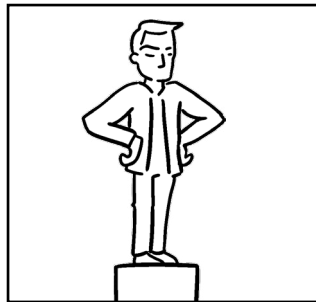

__ulpture

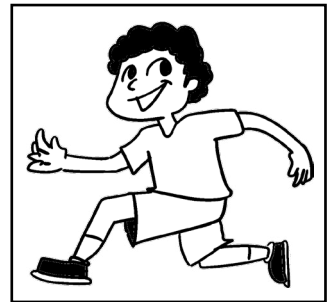

__urry

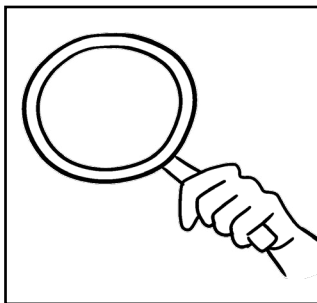

__an

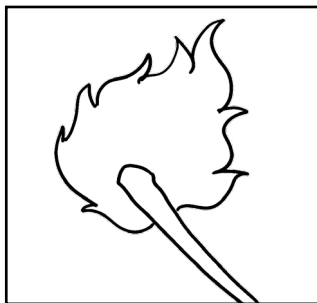

__orch

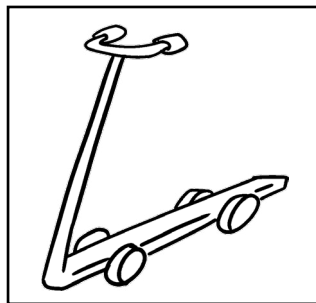

__ooter

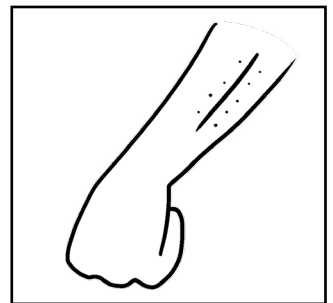

__ar

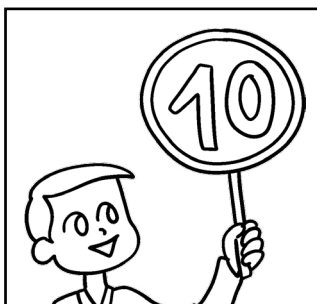

__ore

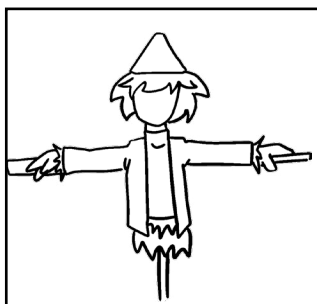

__arecrow

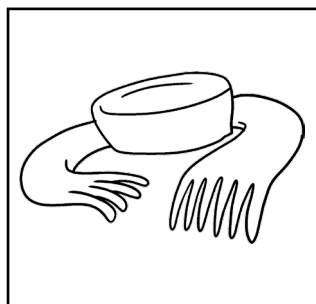

__arf

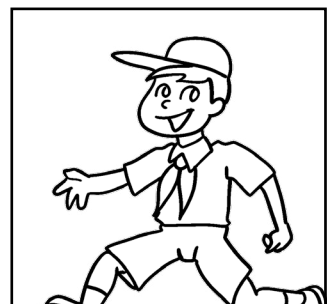

__out

SH Blend Words

NAME: _____

Say the name of the picture. Fill in the letters that make the beginning sound.
Color the picture.

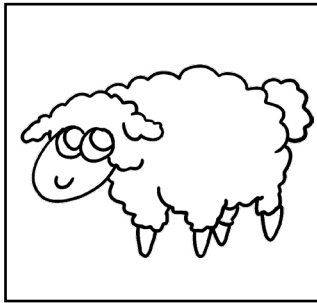

__eep

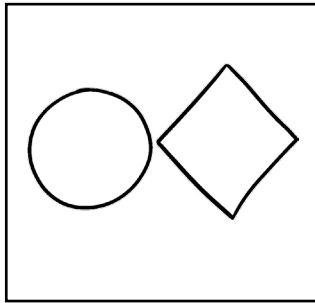

__ape

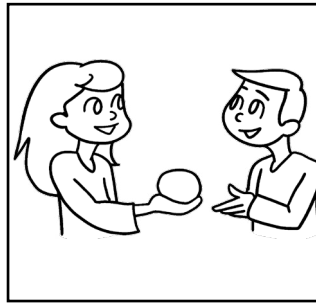

__are

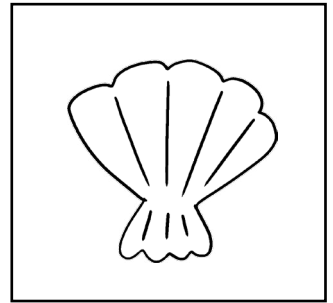

__ell

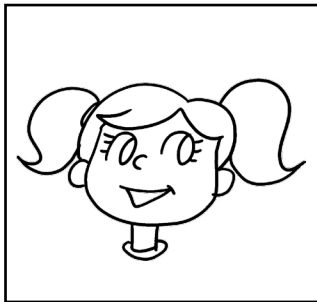

__e



__ould

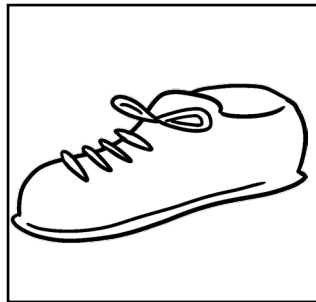

__oe



__oulder



__out

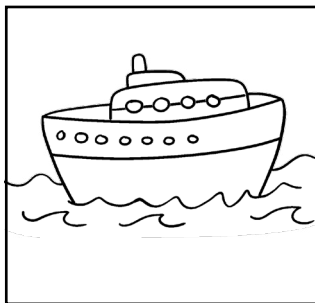

__ip



__op

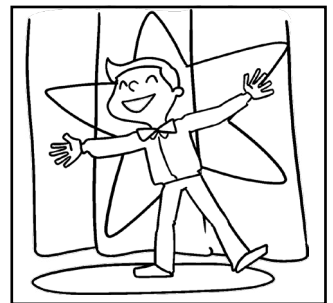

__ow

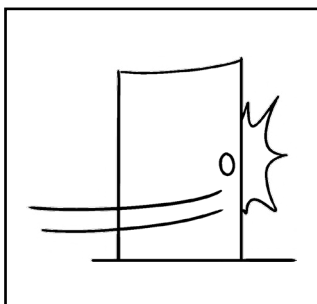

__ut

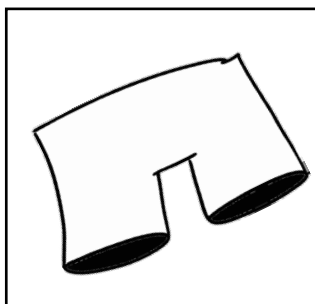

__ort

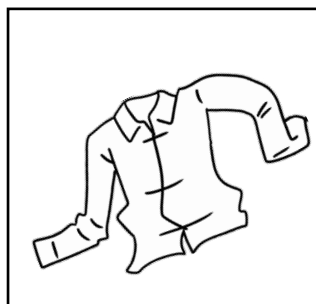

__irt

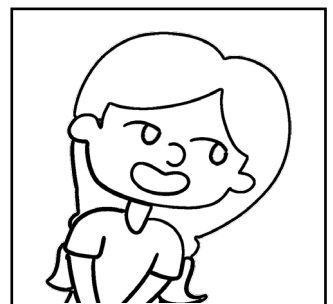

__y

Simon Says

NAME: _____

Simon says

1. Simon Bend your Knees
2. Touch your Ears
3. Touch your Back
4. Jump up and down
5. Snap your fingers
6. Wiggle your Arm
7. Move like a robot
8. Sit down
9. Stand on your toes
10. Air guitar
11. Blink your eyes
12. Wiggle your fingers
13. Make a funny face
14. Hop like a frog
15. Close eyes
16. Says

SK Blend Words

NAME: _____

Say the name of the picture. Fill in the letters that make the beginning sound.
Color the picture.

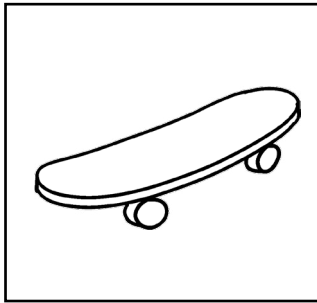

__ate

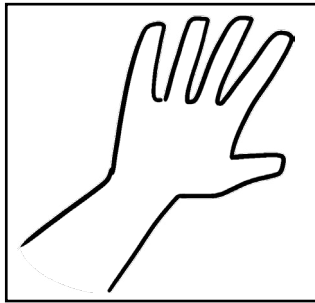

__in

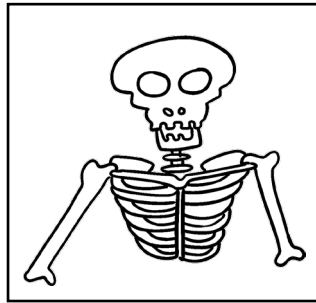

__eleton

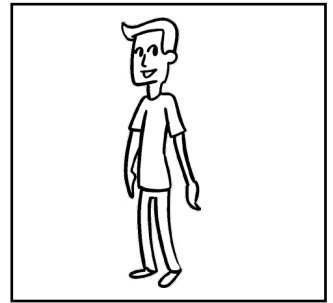

__inner

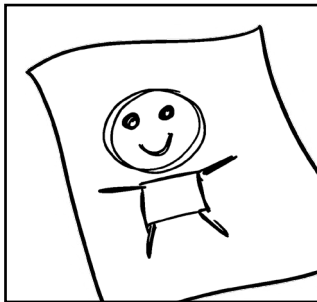

__etch

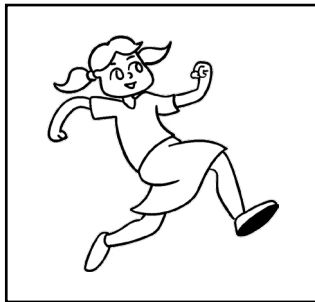

__ip

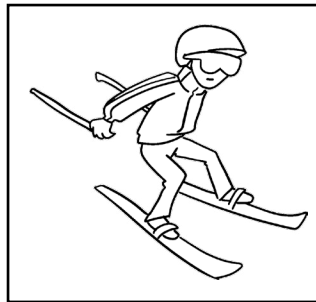

__i

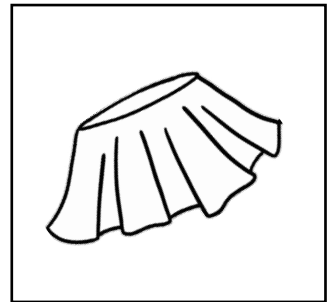

__irt

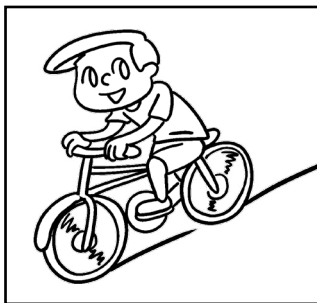

__id

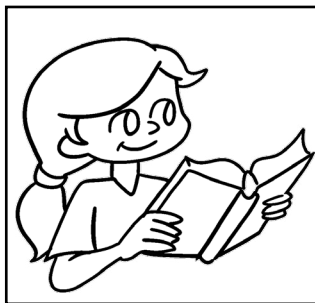

__ill

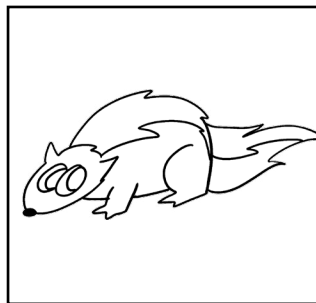

__unk

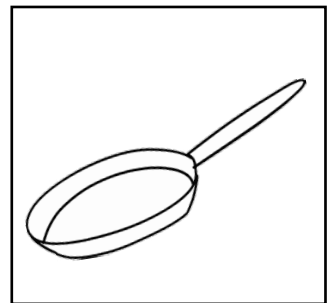

__illet

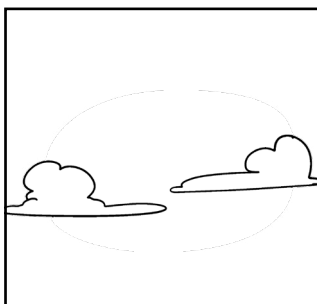

__y

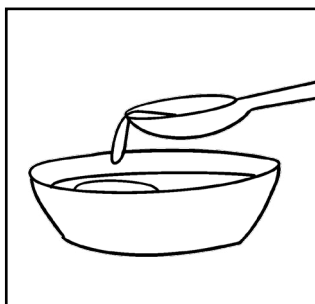

__im

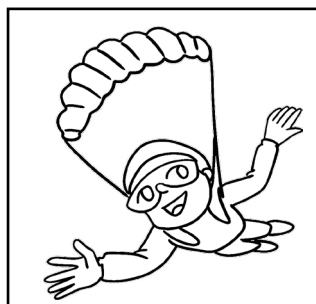

__y diving

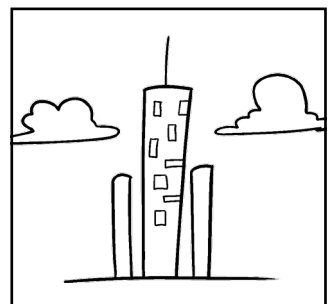

__y scraper

SL Blend Words

NAME: _____

Say the name of the picture. Fill in the letters that make the beginning sound.
Color the picture.

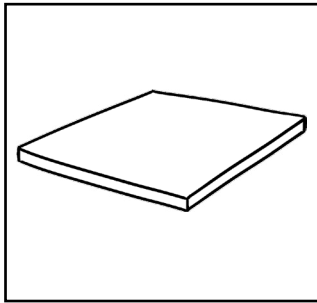

__ab

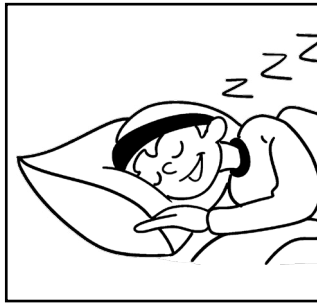

__eep

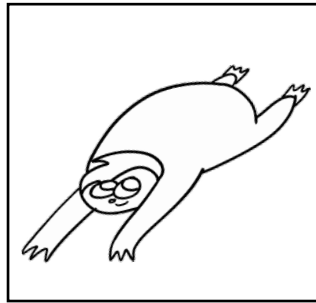

__oth



__ack

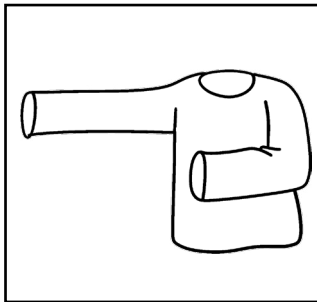

__eeve

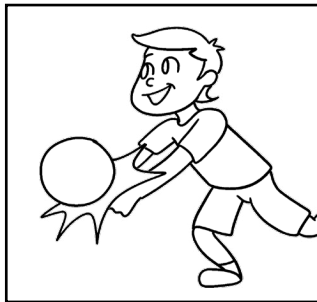

__am

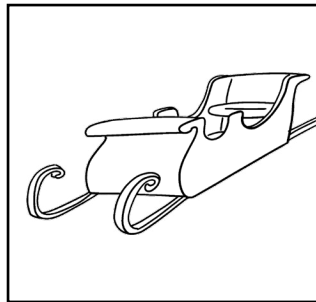

__eigh

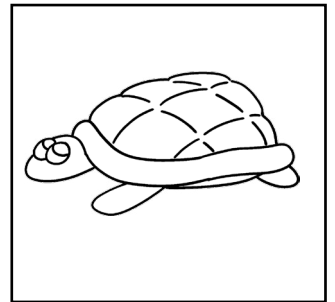

__ow

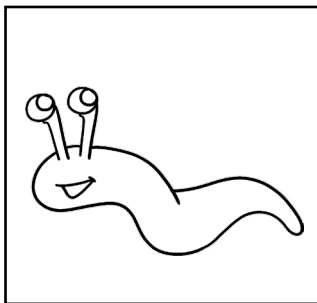

__ug

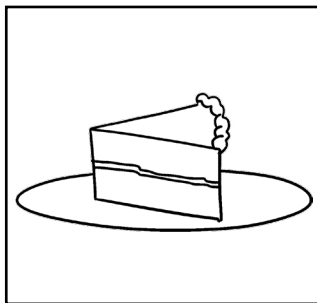

__ice

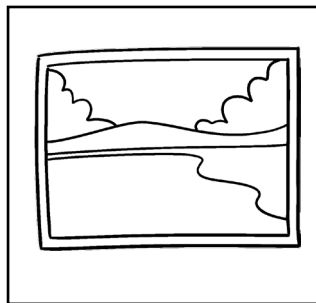

__ide

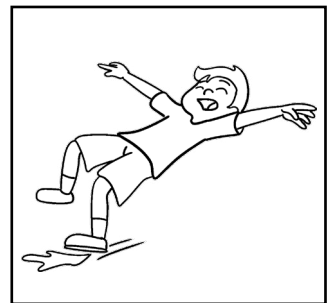

__ip

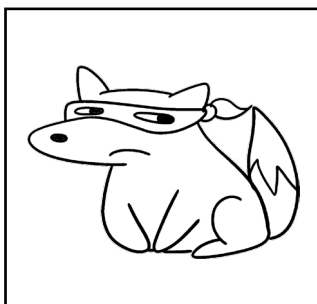

__y

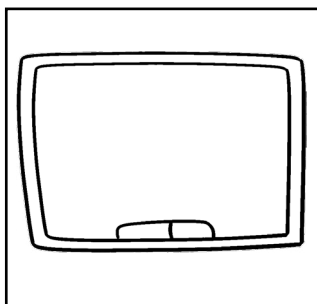

__ate

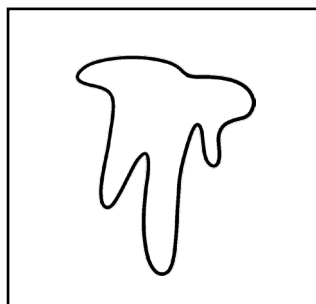

__ime



__ogan

SM Blend Words

NAME: _____

Say the name of the picture. Fill in the letters that make the beginning sound.
Color the picture.

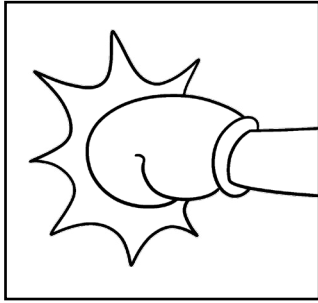

__ack

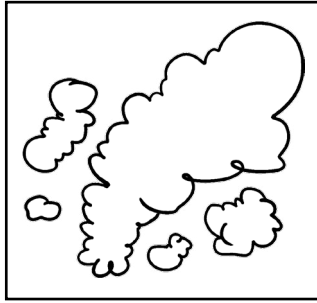

__okey

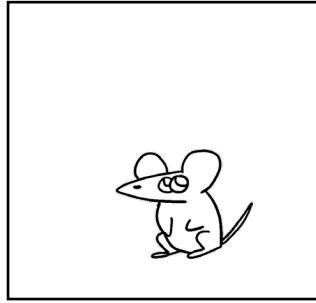

__all

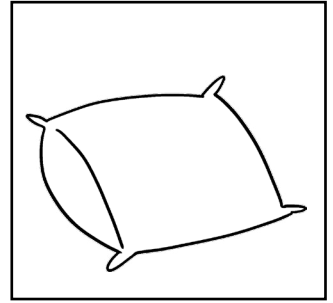

__ooth

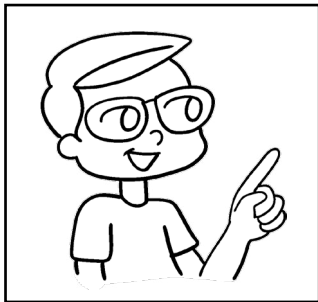

__art

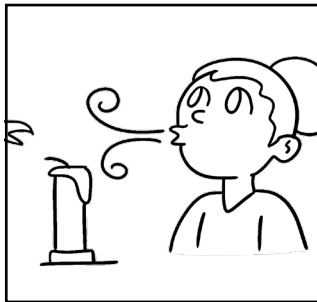

__other

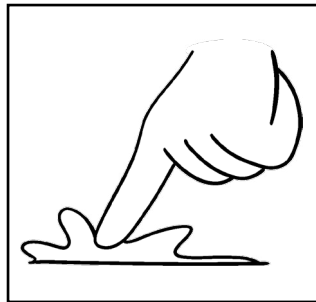

__ash

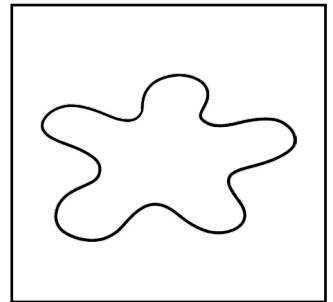

__udge

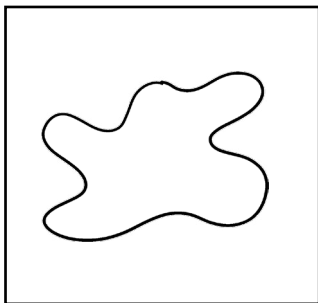

__ear

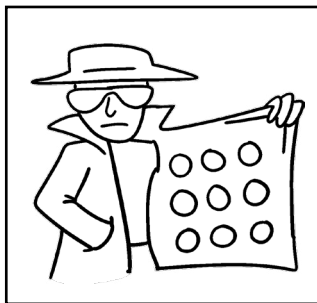

__uggle

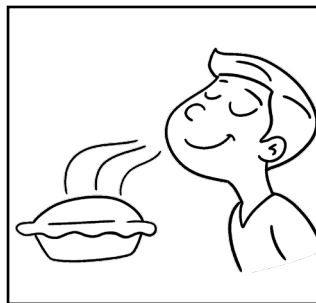

__ell

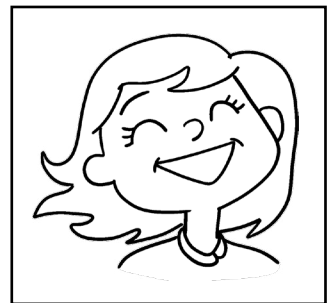

__ile



__ock

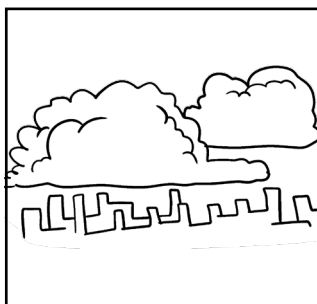

__og

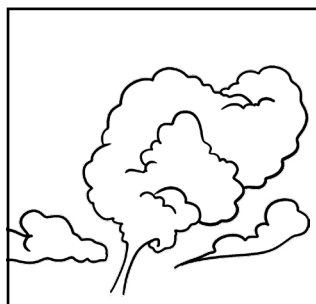

__oke



__oothie

SN Blend Words

NAME: _____

Say the name of the picture. Fill in the letters that make the beginning sound.
Color the picture.

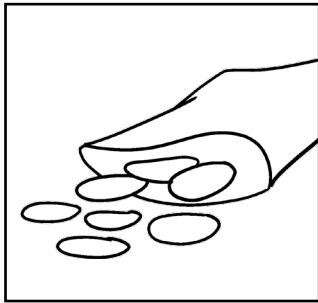

__ack

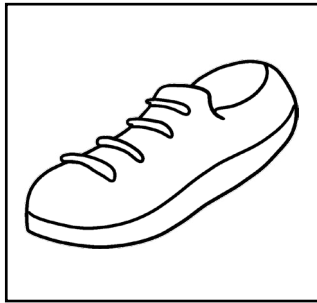

__eaker



__ore

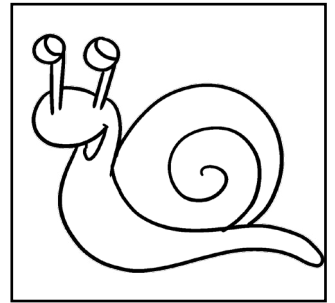

__ail

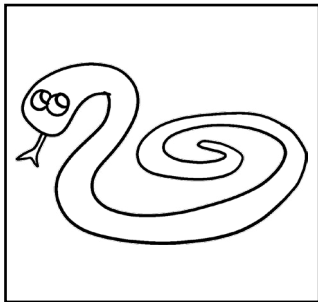

__ake

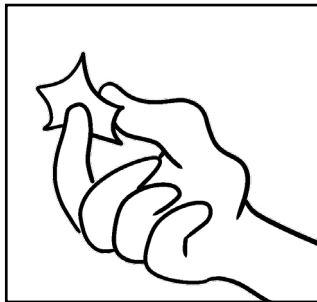

__ap



__eeze

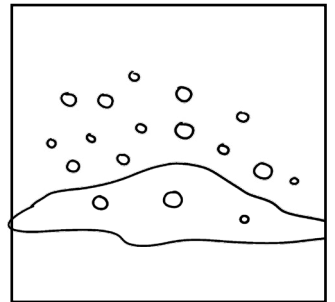

__ow

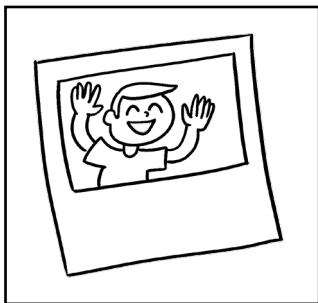

__apshot

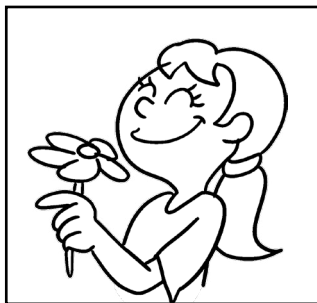

__iff

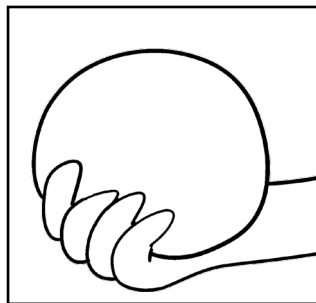

__owball



__owman

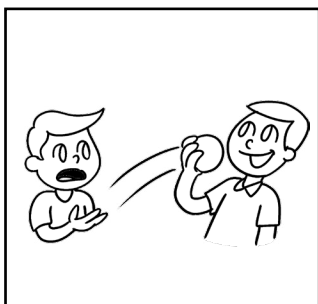

__atch

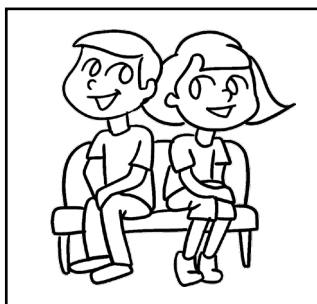

__ug

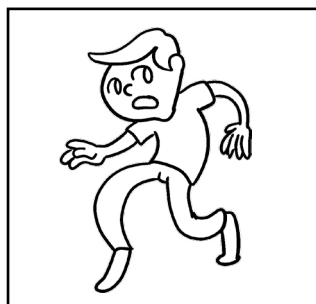

__eak

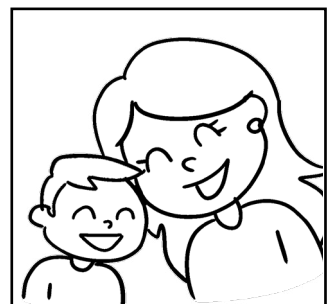

__uggle

SP Blend Words

NAME: _____

Say the name of the picture. Fill in the letters that make the beginning sound.
Color the picture.

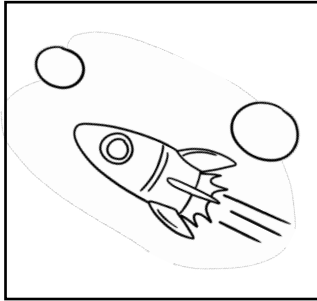

__ace

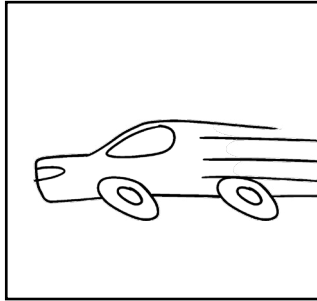

__eed

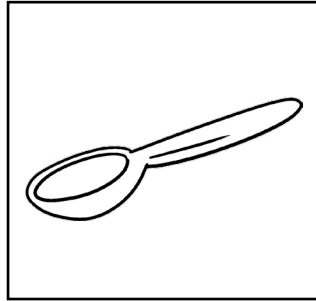

__oon



__ell

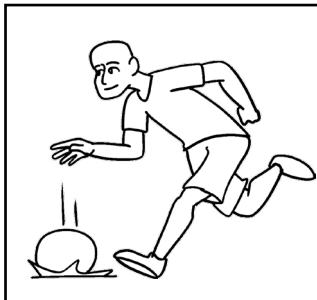

__ort

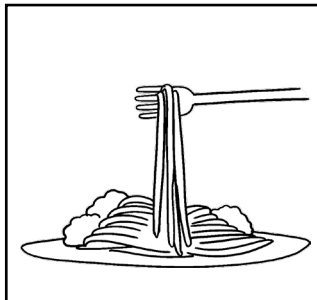

__aghetti

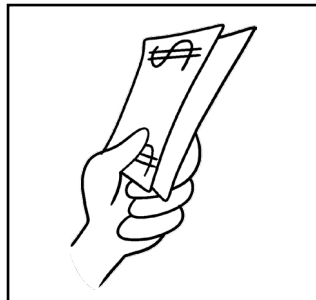

__end

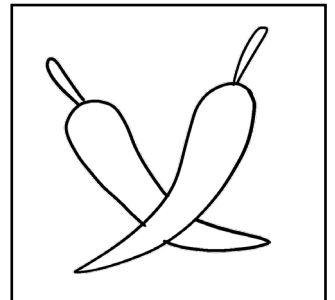

__ice

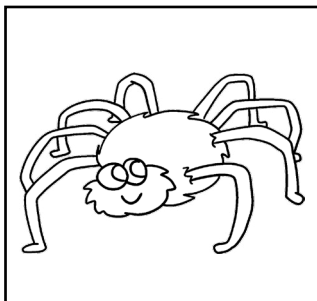

__ider

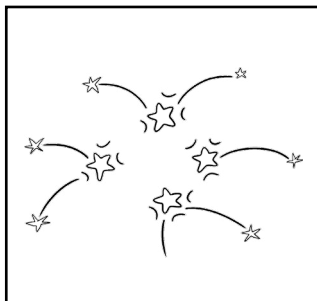

__arkle

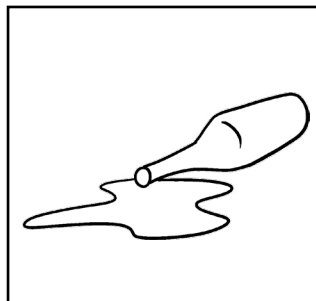

__ill



__eak

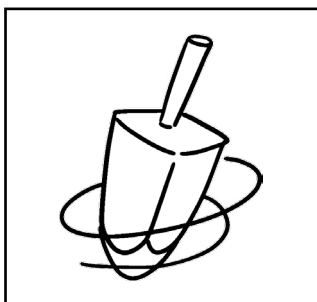

__in

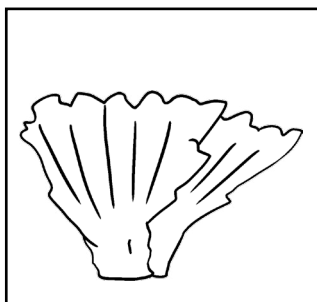

__inach

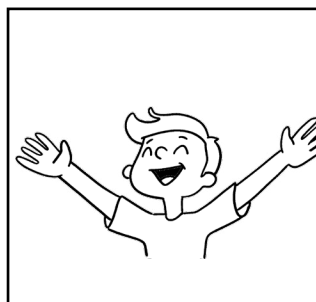

__ecial

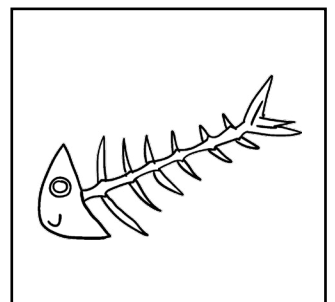

__ine

ST Blend Words

NAME: _____

Say the name of the picture. Fill in the letters that make the beginning sound.
Color the picture.

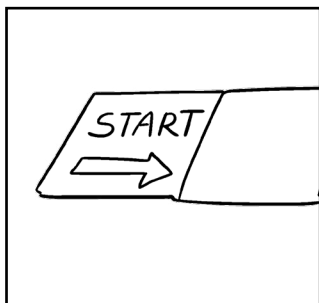

__art

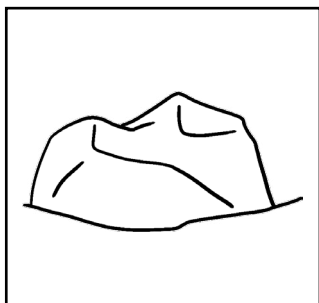

__one

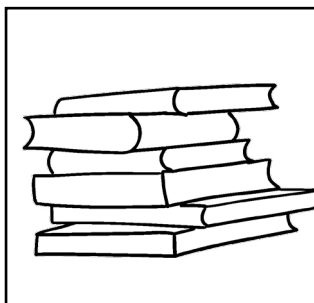

__ack

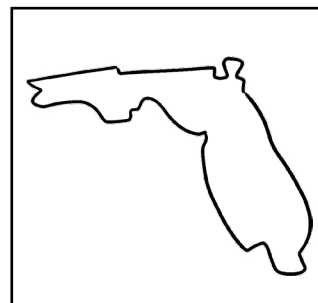

__ate

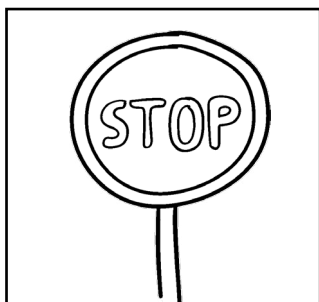

__op



__ay

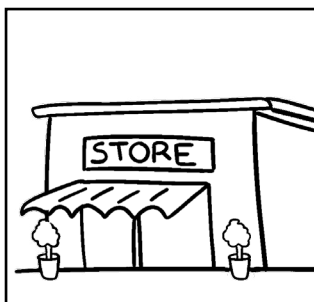

__ore

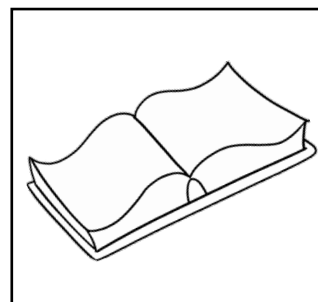

__ory

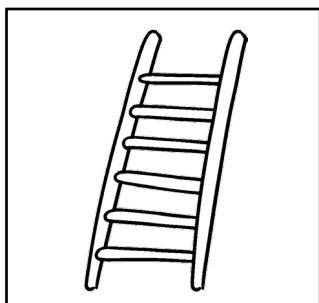

__air

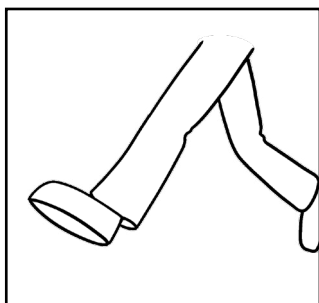

__ep

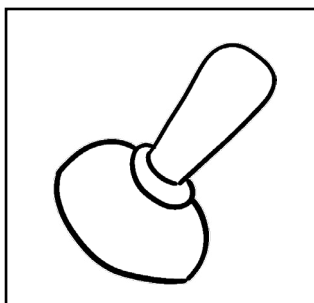

__amp

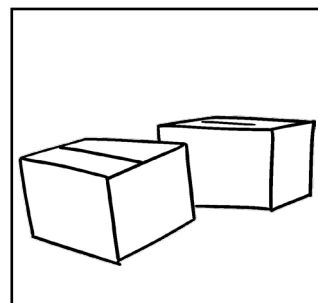

__uff



__and

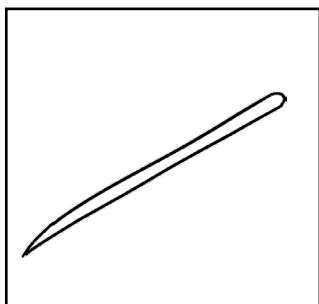

__ick

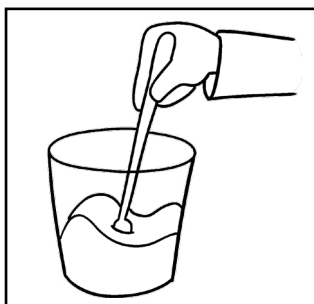

__ir

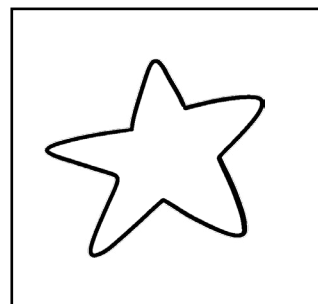

__ar

Stretch and Count to 100

NAME: _____

Fill in the numbers to 100.

1									

SW Blend Words

NAME: _____

Say the name of the picture. Fill in the letters that make the beginning sound.
Color the picture.

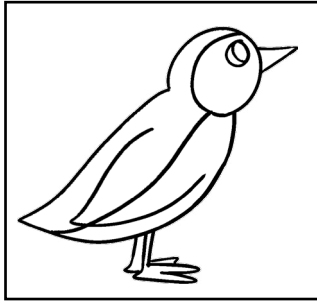

__allow

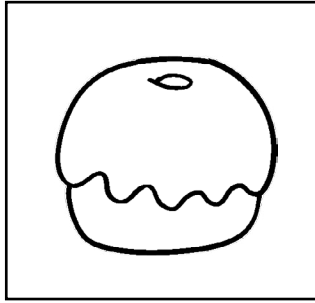

__eet

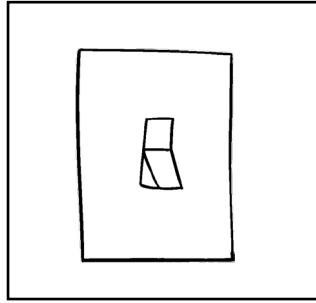

__itch

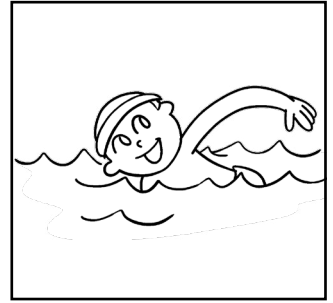

__am

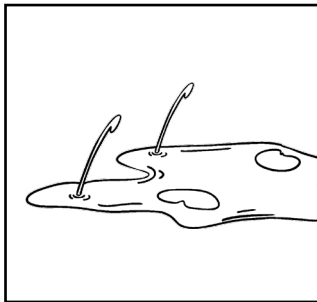

__amp

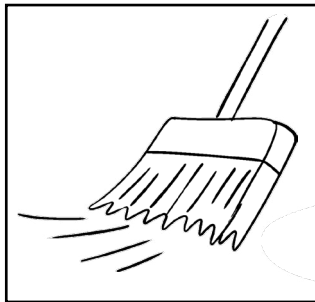

__ept

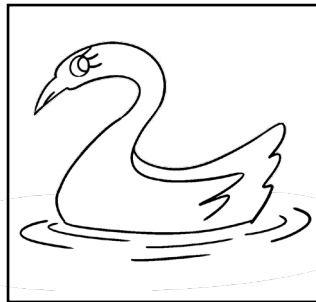

__am

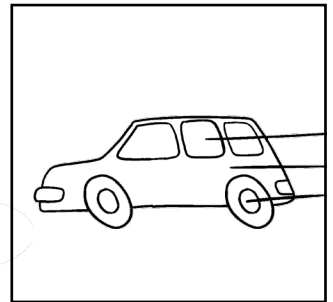

__ift

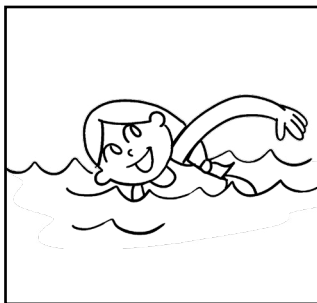

__im

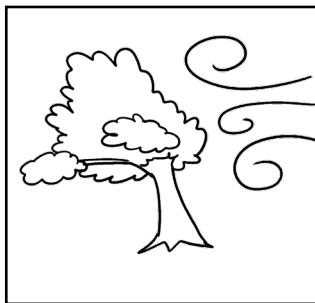

__ay



__eat



__ing

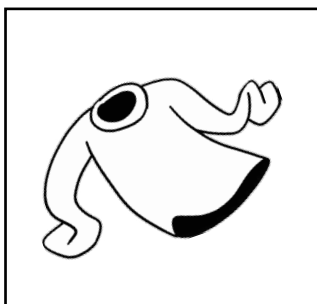

__eater

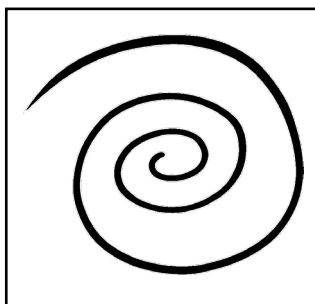

__irl

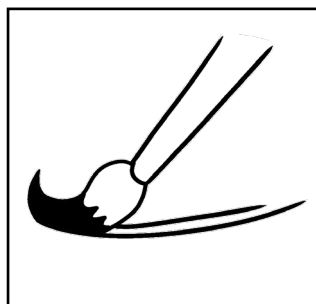

__eep



__ish

Ten Little Kittens

NAME: _____

Write the numbers 1 to 10 in the circles.

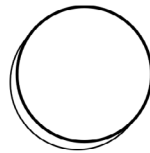
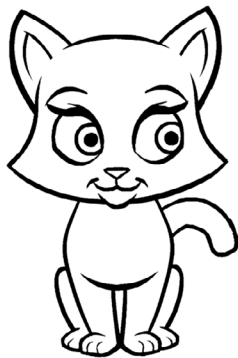
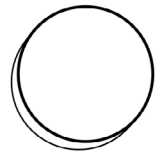
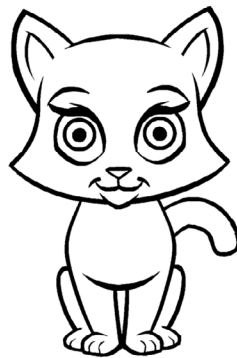
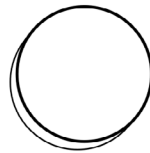
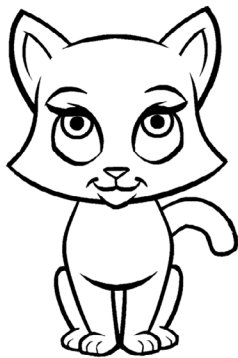
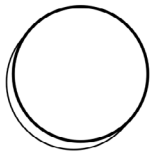
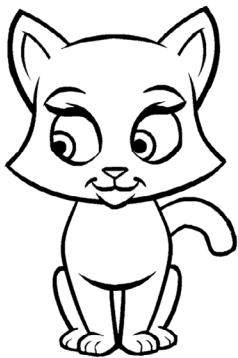
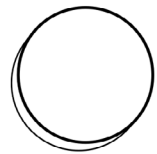
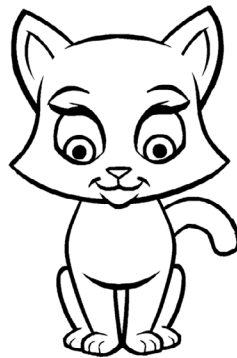
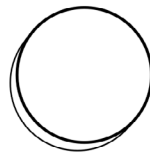
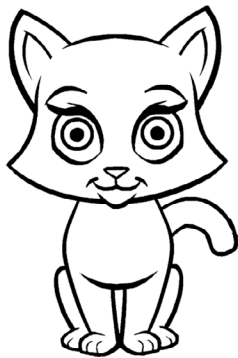
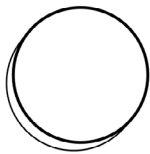
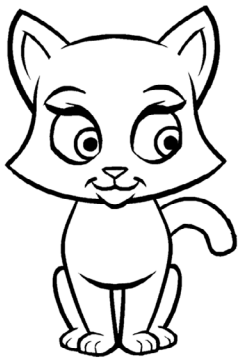
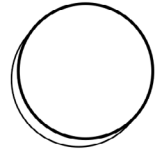
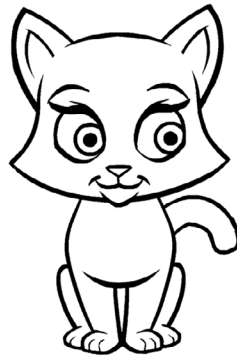
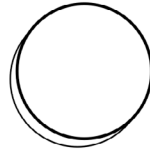
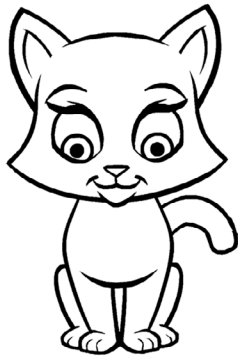
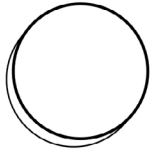
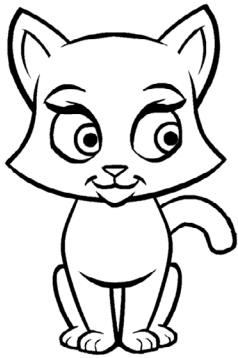

TH Blend Words

NAME: _____

Say the name of the picture. Fill in the letters that make the beginning sound.
Color the picture.

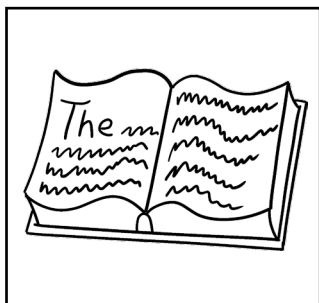

__ e

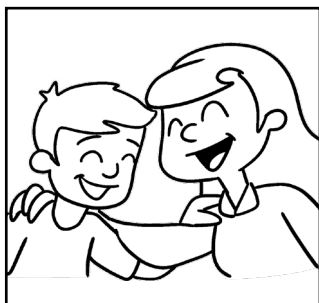

__ ank

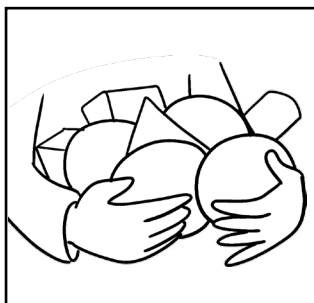

__ ese

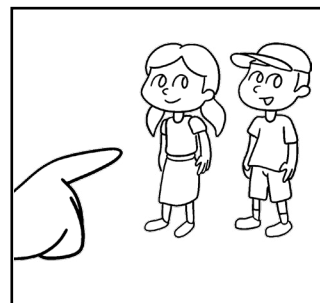

__ ey

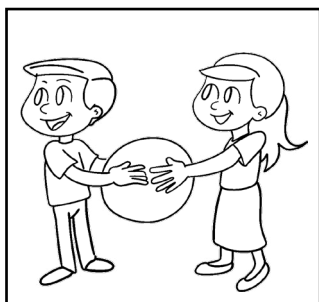

__ eir

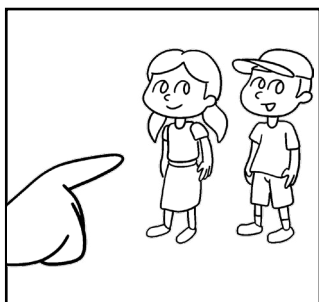

__ em

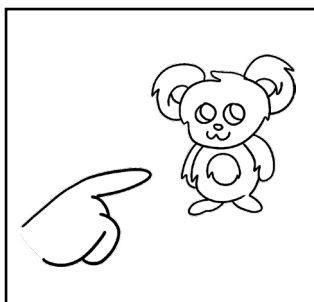

__ at

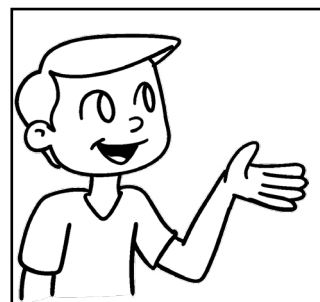

__ en

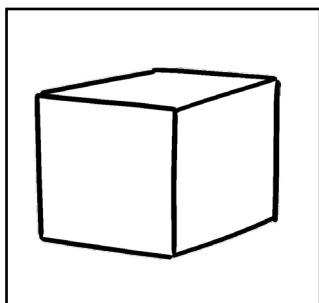

__ ing



__ ink

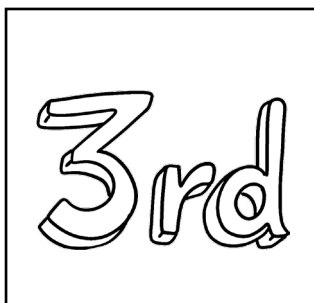

__ ird

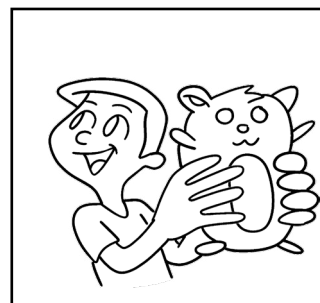

__ is

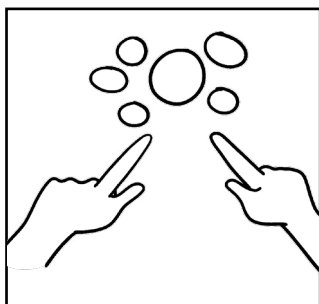

__ ose

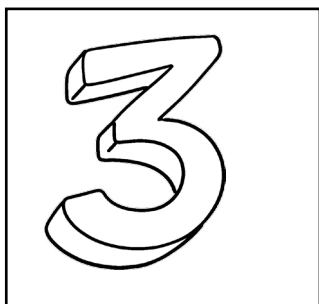

__ ree

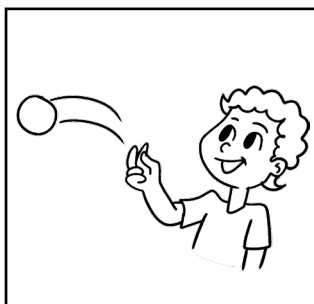

__ row

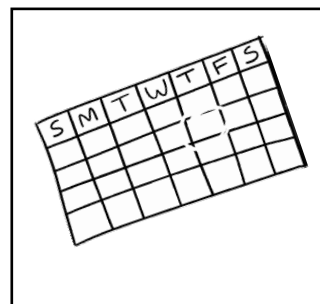

__ ursday

Thank You

NAME: _____

Lyrics page to help learn this song. Sing along!



Two little words
Two little words
Two little words
Not good bye

It's the end of the year
Graduation is here
Our two little words
To our Teachers, Moms, Dads,
Grandparents and All



Thank you, Thank you, Thank you
everyone
Thank you for all you've done
Thank you, thank you, thank you
everyone
Thank you for all you've done

You taught us to read and write
You taught us to learn
You told us it'd be alright
And how to take our turn



Thank you, Thank you, Thank you
everyone
Thank you for all you've done
Thank you, thank you, thank you
everyone
Thank you for all you've done

You helped us to tie our shoes
Learn shapes and colors too
There's so many things you do
We just want to say



Thank you, Thank you, Thank you
everyone
Thank you for all you've done
Thank you, thank you, thank you
everyone
Thank you for all you've done

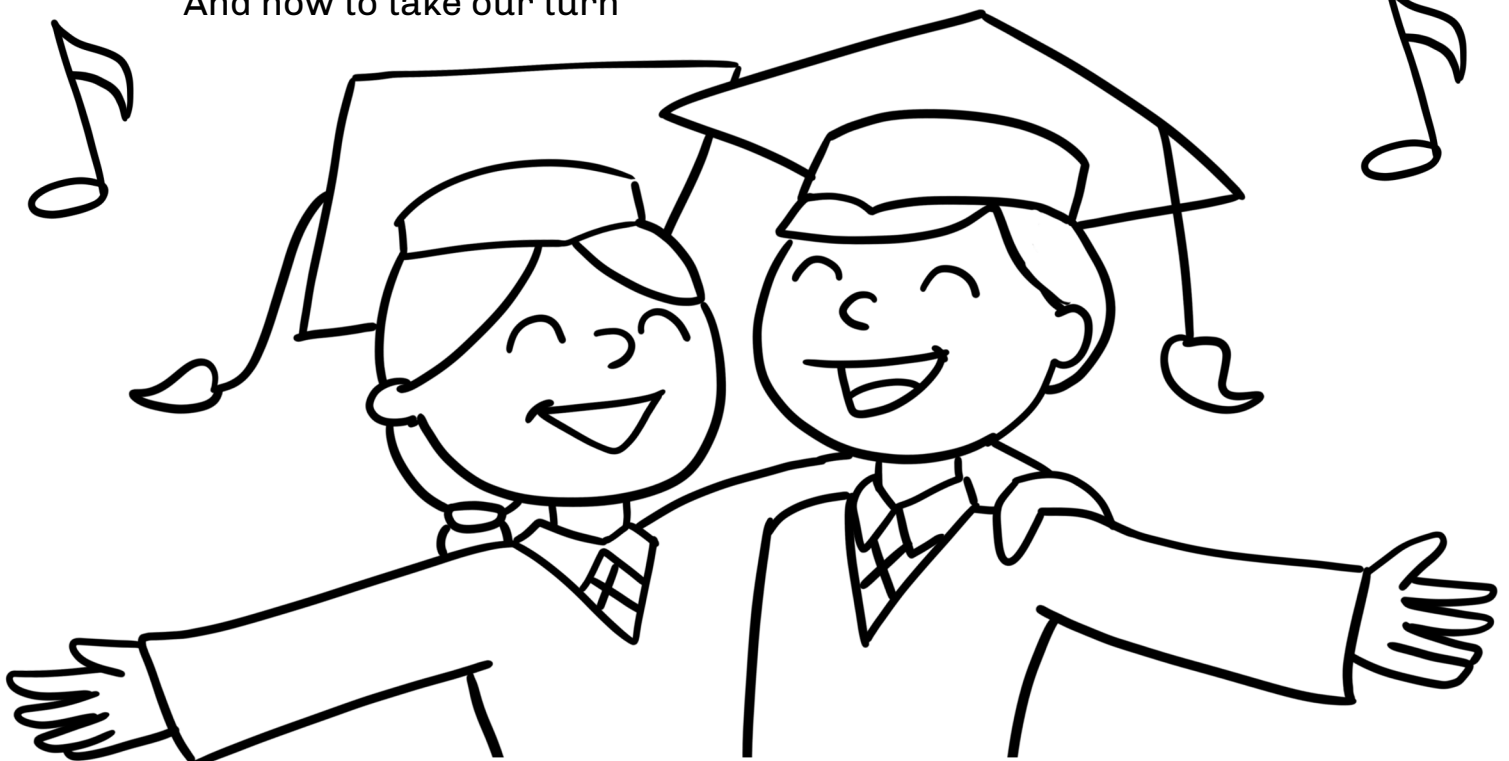

The Letter A

NAME: _____

Word search

J	C	A	S	D	I	V	K	A	Y
A	M	Y	M	B	V	I	B	W	N
L	S	L	A	P	P	L	E	O	B
L	A	A	N	T	L	P	R	H	A
I	C	Q	F	K	L	P	E	M	V
G	O	R	Y	R	A	E	J	L	O
A	R	Z	M	G	B	H	E	Y	C
T	N	C	X	O	L	G	M	S	A
O	E	Y	R	J	N	M	I	S	D
R	A	T	Q	A	L	D	K	Y	O

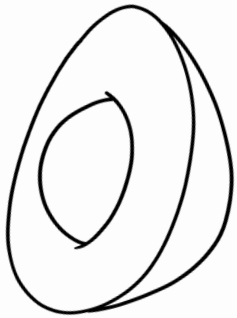
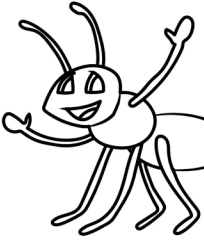

Apple
Alligator
Angel
Acorn

Ant
Avocado
Apron

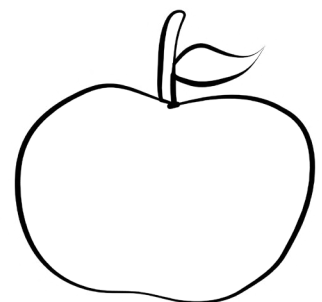

The Letter B

NAME: _____

Word search

Z	B	B	T	B	L	L	U	Q	H
A	B	A	T	F	E	W	Q	Y	I
B	S	N	B	K	U	A	L	B	C
A	W	A	Z	I	O	F	R	H	E
L	X	N	I	X	R	U	P	X	O
L	R	A	S	E	E	D	U	V	Q
O	N	F	T	P	D	Y	Z	I	U
O	M	T	N	Y	L	J	U	O	N
N	U	G	T	H	K	P	X	I	V
B	A	L	L	J	X	X	F	M	K

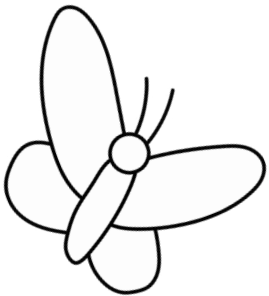
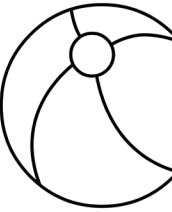
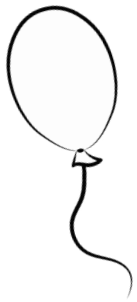

Ball
Butterfly
Bear
Balloon

Bird
Bat
Banana

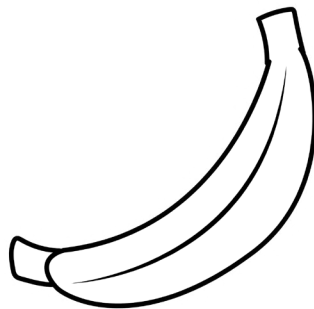
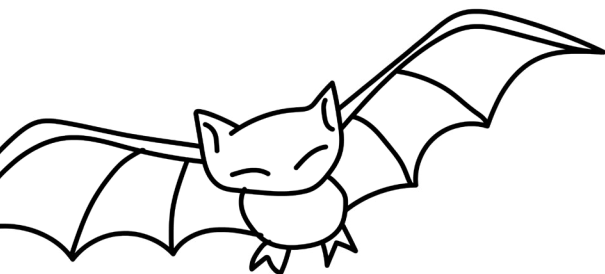

The Letter C

NAME: _____

Word search

O	I	O	G	H	C	A	N	D	Y
Q	N	Q	M	F	Z	V	A	K	Y
C	A	T	U	V	H	X	T	D	I
C	A	R	R	O	T	A	K	H	N
O	Z	K	K	L	O	E	H	S	J
H	C	J	E	C	L	N	Y	P	K
V	F	I	W	D	R	G	C	N	T
A	I	X	N	I	B	T	E	A	R
F	I	A	Q	A	H	B	R	C	R
H	C	B	V	N	P	B	L	M	R

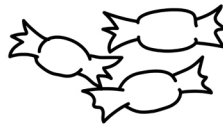
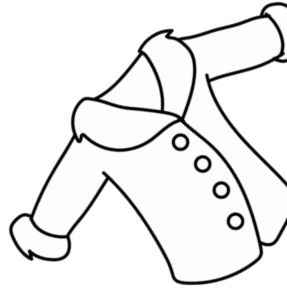

car
candle
carrot
cat

coat
cake
candy

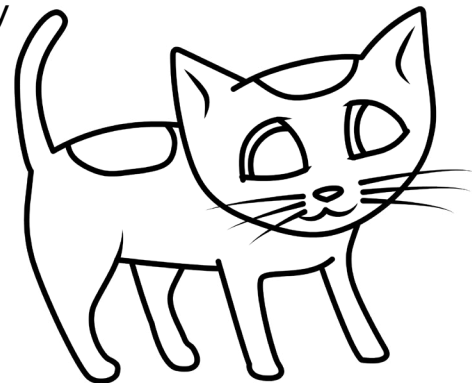
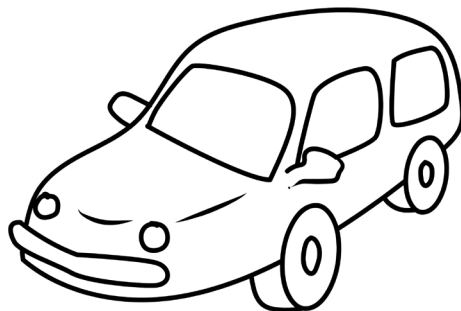

The Letter D

NAME: _____

Word search

G	Y	I	F	I	V	A	W	N	S
D	Z	D	O	C	T	O	R	T	F
O	B	I	O	X	S	J	S	T	A
L	D	N	N	O	B	T	F	Z	W
P	D	O	J	P	R	M	P	N	K
H	I	S	N	Y	H	V	R	C	B
I	U	A	K	U	C	K	U	S	I
N	K	U	A	U	T	D	Z	B	D
G	D	R	H	X	E	U	D	O	G
M	F	L	G	A	C	P	X	H	X

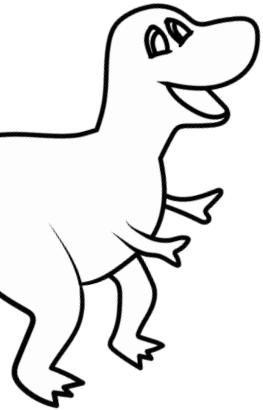

dog
duck
doctor
door

dinosaur
donut
dolphin

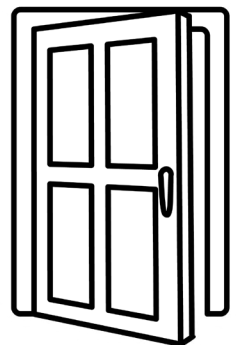
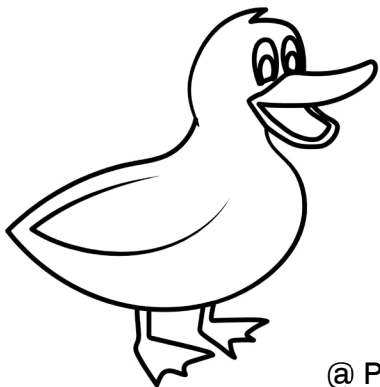

The Letter E

NAME: _____

Word search

V	G	E	G	E	A	R	P	U	G
H	H	G	L	W	H	Z	E	P	G
N	E	G	T	A	E	A	G	L	E
S	Q	P	X	B	L	S	P	V	A
V	E	L	V	V	E	Q	A	H	T
M	Q	A	H	S	P	C	J	U	Z
A	U	N	B	K	H	A	K	V	X
E	A	T	C	T	A	B	G	C	O
P	L	T	Z	R	N	B	B	W	R
N	I	G	U	S	T	S	P	V	J

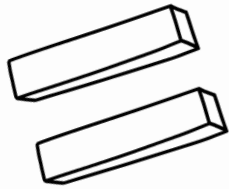
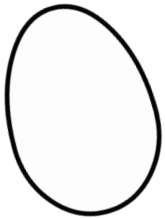

egg
elephant
ear
eagle

eggplant
equal
eat

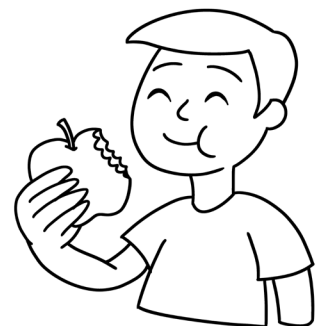
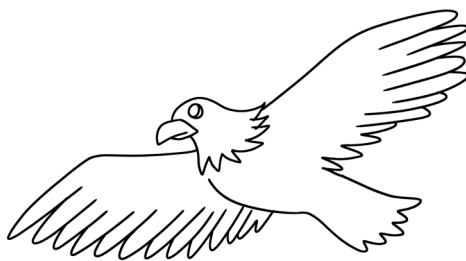
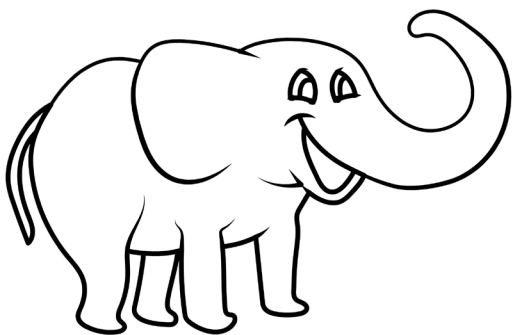

The Letter F

NAME: _____

Word search

X	U	G	B	O	D	Q	F	M	R
N	O	A	F	E	F	Y	L	D	Q
N	Z	G	K	O	Y	I	A	M	W
C	B	P	O	Z	U	I	S	R	F
F	E	A	T	H	E	R	H	H	R
I	O	I	X	O	C	F	L	A	F
N	D	R	I	B	Q	P	I	G	A
G	Z	Y	K	X	E	F	G	D	N
E	Z	M	R	G	T	P	H	B	I
R	X	G	B	D	U	S	T	X	V

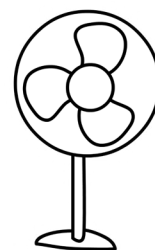
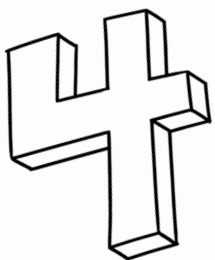

fish
finger
flashlight
fork

four
fan
feather

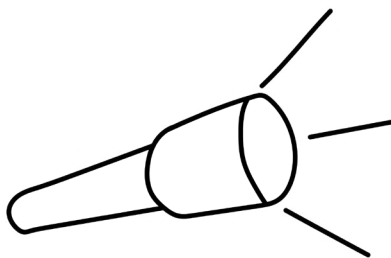
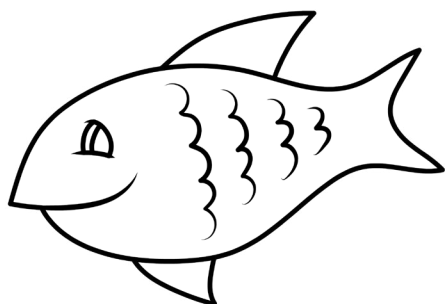

The Letter G

NAME: _____

Word search

W	V	P	U	C	L	D	L	K	N
S	G	O	R	I	L	L	A	S	Y
R	O	O	G	W	N	Q	W	X	M
H	L	I	U	I	W	L	F	K	S
G	F	B	M	M	R	W	G	P	K
B	Y	Y	U	I	Y	A	P	G	D
Q	H	V	G	D	A	V	F	I	T
H	Z	Z	O	G	D	Y	X	F	F
E	P	T	A	M	F	B	D	T	E
E	Z	Y	T	T	Y	A	D	M	V

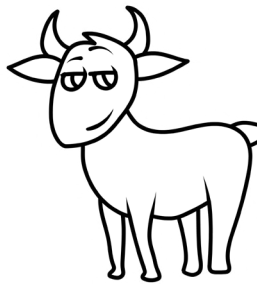

giraffe
goat
gorilla
gift



girl
gum
golf

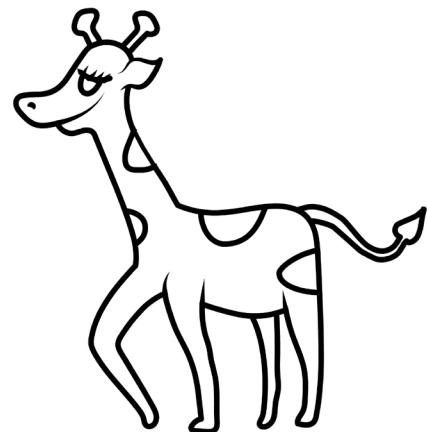

The Letter H

NAME: _____

Word search

H	G	H	V	B	T	W	A	J	S
P	A	M	A	R	Z	H	S	H	O
L	E	N	A	A	A	B	H	A	T
C	J	E	D	N	N	O	H	M	T
Z	H	I	N	S	H	K	P	B	F
R	Q	M	M	S	I	A	R	U	D
P	R	P	G	H	P	G	M	R	L
X	H	O	R	N	P	X	M	G	A
C	Q	I	G	Y	O	Z	T	E	S
Z	R	H	A	T	S	M	F	R	Y

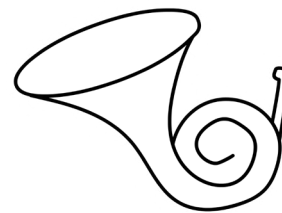

Hand
ham
hat
hamburger

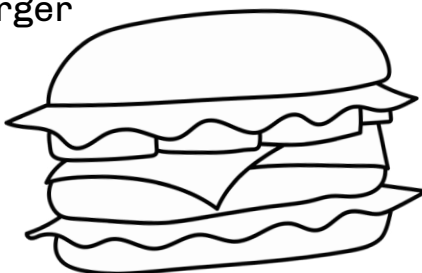

horn
hippo
heart

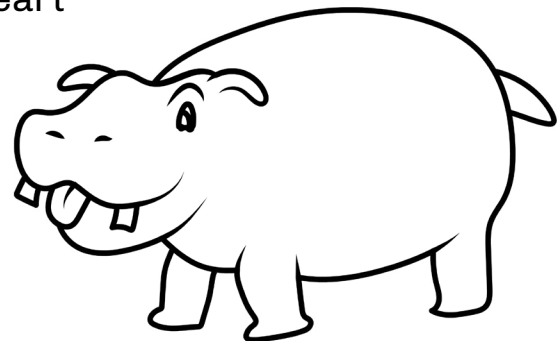

The Letter I

NAME: _____

Word search

K	A	Q	I	I	R	O	N	Y	O	I
J	K	G	C	G	V	P	O	G	X	L
L	Y	T	V	Z	L	A	S	K	U	Z
H	A	F	E	K	D	O	H	D	T	G
L	I	N	S	E	C	T	O	Y	M	R
I	N	S	T	R	U	M	E	N	T	S
C	O	Y	I	C	E	C	R	E	A	M
E	L	D	I	Z	R	G	V	L	M	M
W	G	D	X	X	M	G	U	M	X	T
Q	Y	X	S	J	W	Y	H	Q	O	U
K	O	Z	U	P	I	G	U	A	N	A

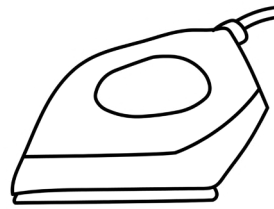
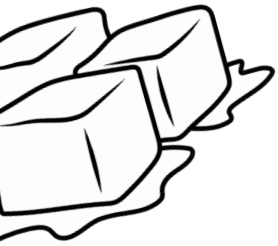
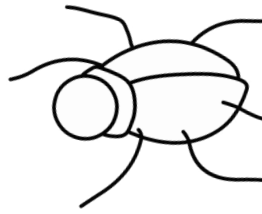

igloo
ice cream
ice
insect

iguana
iron
instruments

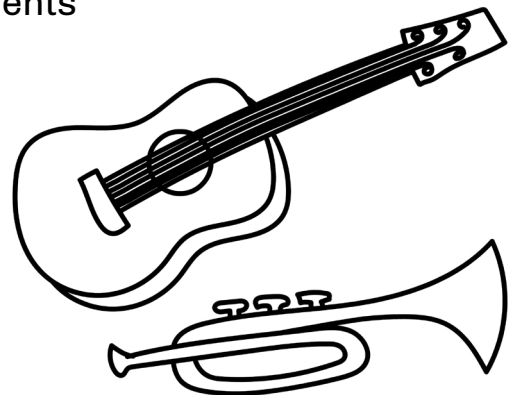
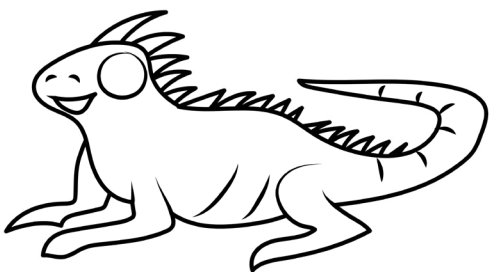

The Letter J

NAME: _____

Word search

Z	Y	Z	O	W	H	O	G	B	H
E	J	E	L	L	Y	F	I	S	H
K	V	V	I	B	H	T	P	B	R
R	J	V	S	J	E	N	W	J	M
N	Z	A	B	J	J	U	I	C	E
H	T	A	G	O	C	P	B	T	F
C	Z	D	R	U	Z	I	V	P	N
B	H	I	G	R	A	R	Z	J	W
B	N	U	T	J	E	R	U	A	E
B	J	A	C	K	E	T	V	R	V

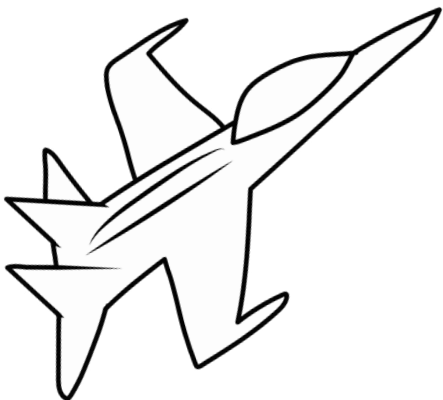

juice
jellyfish
jacket
jet

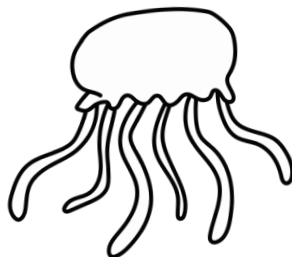

jar
jaguar
jug

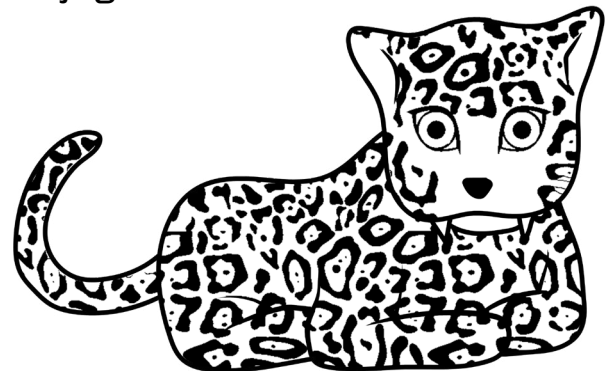

The Letter K

NAME: _____

Word search

L	D	K	Q	I	L	E	D	T	U
M	T	E	K	I	T	T	E	N	Z
S	M	Y	B	O	G	D	K	X	K
T	D	K	O	A	L	A	A	B	E
K	L	P	L	A	D	P	N	K	Y
G	A	D	O	W	M	B	G	A	B
W	M	H	M	E	K	T	A	Y	O
Q	N	Y	T	L	I	G	R	A	A
E	R	S	H	G	T	I	O	K	R
P	U	W	J	S	E	U	O	Y	D



kangaroo
key
kite
kitten

koala
kayak
keyboard

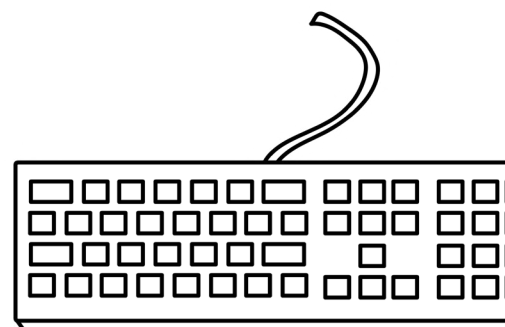
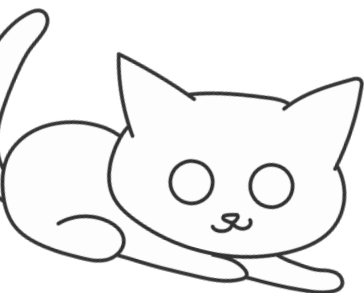

The Letter L

NAME: _____

Word search

E	C	V	E	H	H	Z	D	C	L
L	A	L	A	B	R	A	Z	S	R
E	Y	Q	M	G	G	A	D	K	L
A	B	A	D	I	S	F	V	C	I
F	L	O	L	L	I	P	O	P	Z
C	L	I	O	N	D	Y	M	Y	A
Z	L	A	D	D	E	R	C	K	R
A	N	E	D	S	T	A	T	P	D
Q	V	L	A	D	Y	B	U	G	U
J	C	S	I	P	C	I	X	Z	H

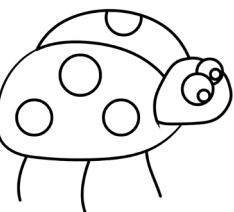
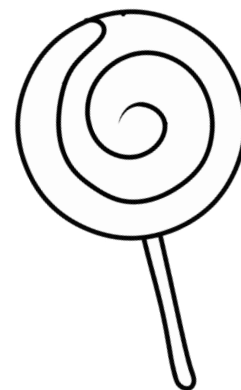

lion
leaf
lizard
ladybug

lollipop
lamb
ladder

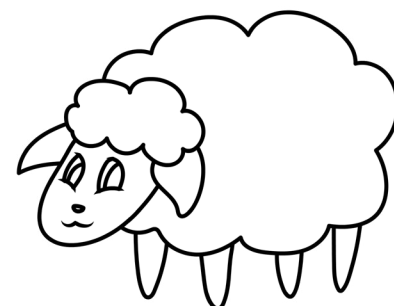
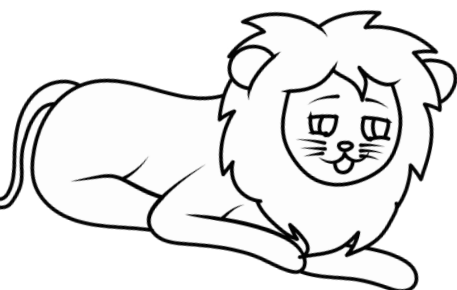

The Letter M

NAME: _____

Word search

W	M	O	N	K	E	Y	V	D	H
I	O	H	H	L	S	A	I	L	Q
S	O	C	M	A	I	L	B	O	X
P	N	C	O	P	V	W	M	A	T
D	G	M	U	A	L	N	E	L	V
G	F	F	S	B	N	K	U	R	V
J	B	E	E	G	C	D	N	U	U
L	N	M	U	S	H	R	O	O	M
F	P	M	F	V	T	R	X	U	T
J	A	D	A	K	Z	W	O	K	W

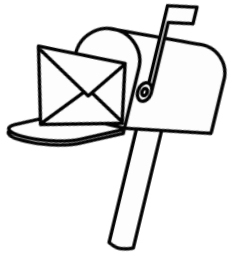

mouse
monkey
ma
moon

mug
mushroom
mailbox

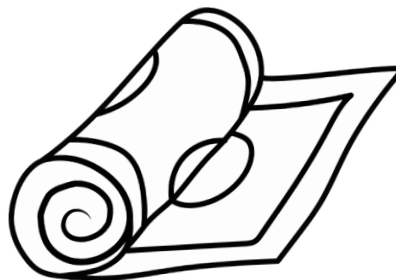

The Letter N

NAME: _____

Word search

Y	J	Y	O	C	T	F	N	J	L
K	V	W	K	M	O	C	O	W	O
M	Z	F	T	B	K	I	T	L	B
F	F	M	D	F	X	N	E	Z	V
T	I	A	S	Z	T	R	N	E	T
U	G	N	D	L	D	K	L	O	D
S	N	E	S	T	N	D	R	K	Q
R	O	S	R	Q	E	N	S	T	K
Z	S	G	I	E	N	A	I	L	F
P	E	I	N	U	T	S	Y	C	X



Nose
nail
net
nest

nuts
note
needle

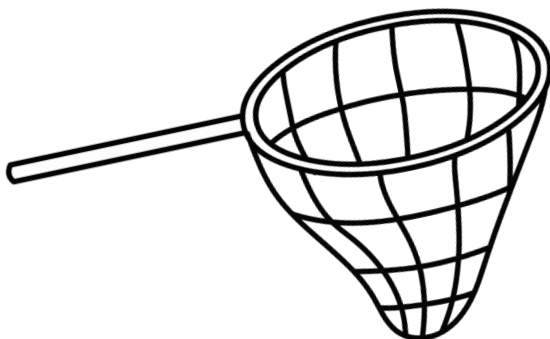

The Letter O

NAME: _____

Word search

X	E	G	P	U	G	D	R	O	M
B	Q	F	P	R	Z	D	V	X	W
L	I	K	L	P	Y	W	S	O	E
J	W	W	T	U	U	M	S	G	O
O	C	T	O	P	U	S	N	P	S
W	I	O	O	G	Q	A	A	M	T
N	B	L	C	N	R	D	U	L	R
K	X	I	E	O	W	N	H	C	I
C	W	V	A	Z	M	F	A	M	C
G	U	E	N	O	A	T	S	J	H

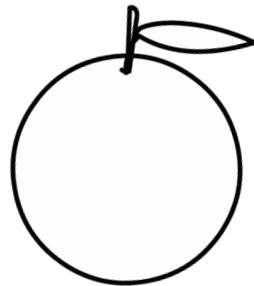
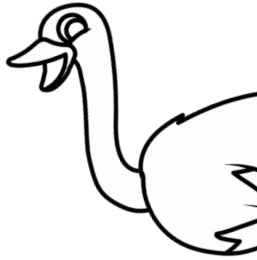

octopus
orange
olive,
ostrich

oats
ox
ocean

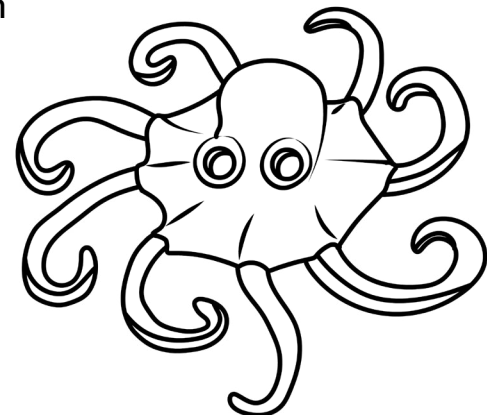
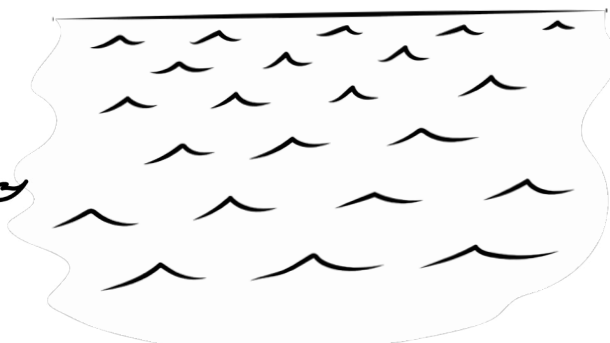
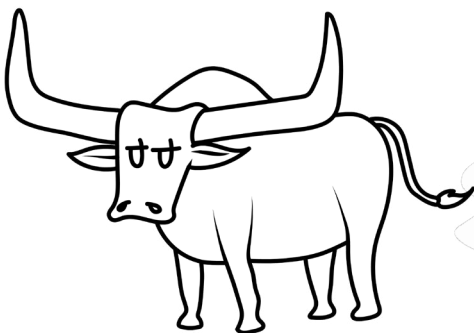

The Letter P

NAME: _____

Word search

P	A	N	D	A	V	N	H	C	J
P	W	P	I	G	K	D	N	O	I
U	R	A	P	J	L	T	F	Z	P
M	Z	G	B	E	T	P	R	F	R
P	E	A	R	N	A	E	U	S	Z
K	I	P	Q	H	Y	N	T	J	E
I	P	C	S	N	Q	G	U	C	G
N	L	T	K	W	H	U	S	T	E
N	A	H	M	L	I	I	W	K	W
N	Q	E	D	X	E	N	V	V	T

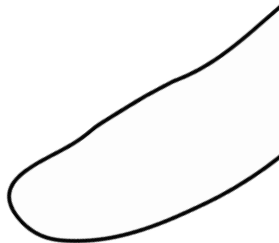
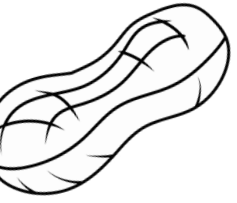
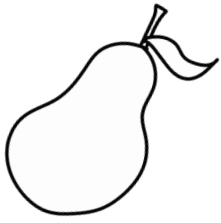

pumpkin
peanut
panda
pig

pickle
penguin
pear

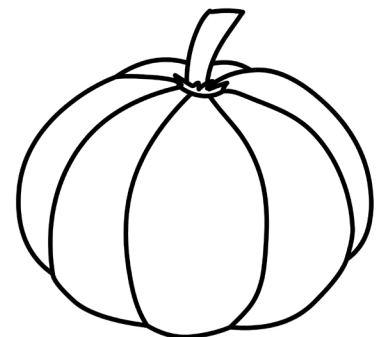
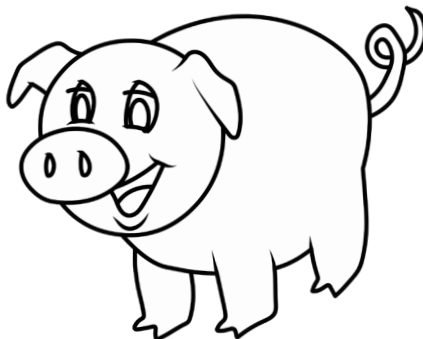

The Letter Q

NAME: _____

Word search

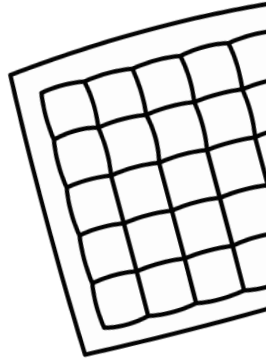

K	I	E	Q	U	L	C	O	D	G	R	N
E	S	T	D	V	Z	W	E	G	E	H	T
T	K	O	A	Q	U	I	L	L	P	O	G
F	O	Q	U	A	R	T	E	R	S	W	V
J	D	C	X	K	O	F	T	B	E	Z	N
W	Y	U	B	O	T	S	N	N	E	D	F
Q	J	S	N	Y	Q	Y	J	Y	Q	V	V
J	Y	V	U	X	U	L	N	V	U	Z	Y
Q	U	E	S	T	I	O	N	M	A	R	K
R	T	D	Q	U	E	E	N	R	I	A	Q
K	U	W	E	R	T	N	P	I	L	O	I
E	Q	U	I	L	T	Q	D	A	X	Z	J



quarter
queen
quilt

question mark

quill
quail
quiet

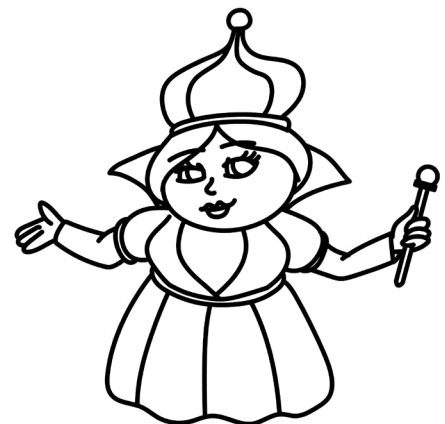
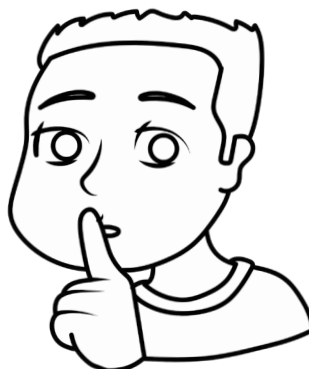

The Letter R

NAME: _____

Word search

R	I	N	G	I	W	V	M	Q	M
R	X	P	A	K	Y	D	T	R	D
A	Y	R	O	S	E	W	L	O	B
I	B	A	A	H	C	R	Q	C	P
N	R	B	O	K	C	O	L	K	A
B	G	B	B	W	E	B	F	E	R
O	H	I	B	D	L	O	W	T	A
W	J	T	U	W	O	T	A	Z	A
Q	T	A	L	K	M	V	Q	F	X
W	W	M	C	X	B	T	J	K	B

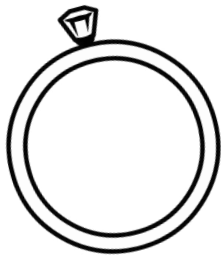
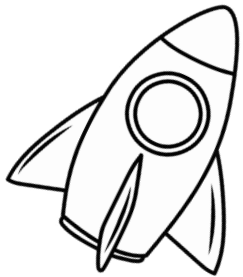

rabbit
ring
rose
robot

rainbow
rocket
rake,

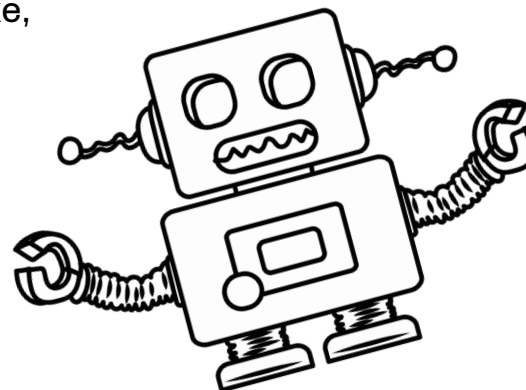
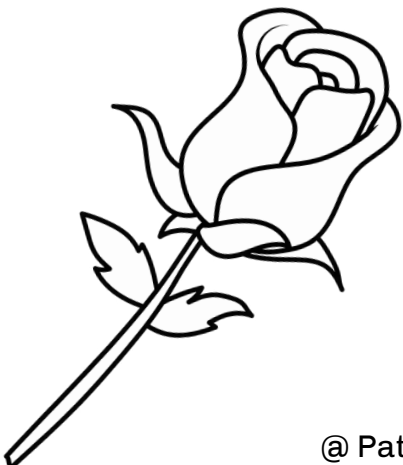

The Letter S

NAME: _____

Word search

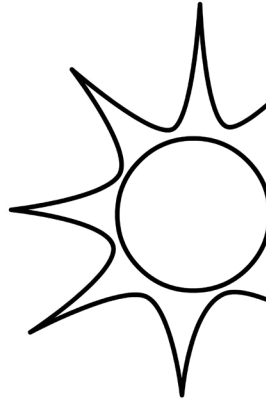

S	H	I	P	D	L	G	J	Y	K
U	X	H	T	V	S	G	H	J	E
N	M	S	V	X	C	C	Z	S	H
L	P	X	F	M	I	S	A	D	C
X	S	C	F	W	S	H	G	H	L
O	R	O	D	D	S	E	H	P	O
U	K	N	A	T	O	E	M	F	S
V	A	T	M	P	R	P	C	F	P
S	O	C	C	E	R	B	A	L	L
S	H	A	B	L	G	P	M	L	G

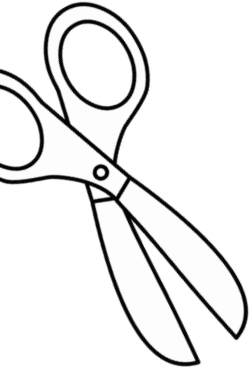

soap
sandwich
soccerball
scissor

sheep
ship
sun

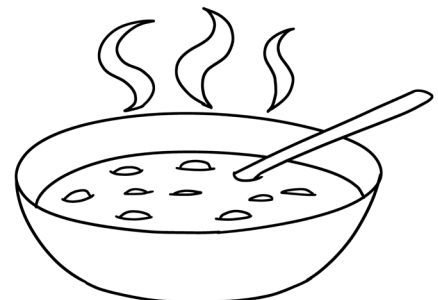
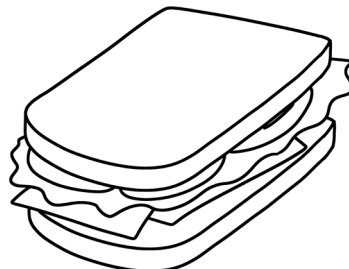
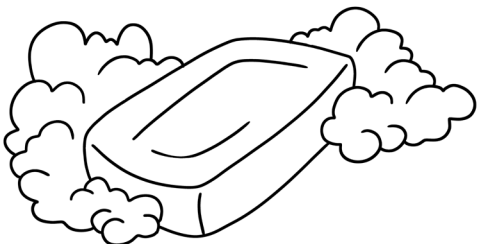

The Letter T

NAME: _____

Word search

V	N	M	U	T	M	V	I	S	C
T	T	K	G	E	U	M	U	B	N
S	O	R	F	N	Q	K	S	B	G
H	O	E	R	T	J	D	L	U	J
I	T	D	J	E	F	X	T	K	O
R	H	T	N	T	O	M	A	T	O
T	N	K	A	E	I	B	C	I	V
B	W	Q	R	B	E	F	O	E	Y
O	F	W	O	S	L	G	T	R	A
N	W	G	R	S	A	E	W	E	L

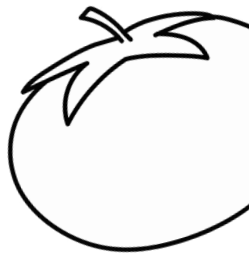
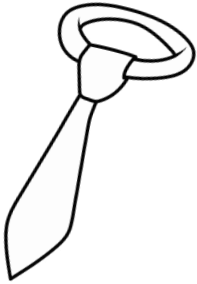

tomato
tooth
tent
tshirt

tie
taco
table

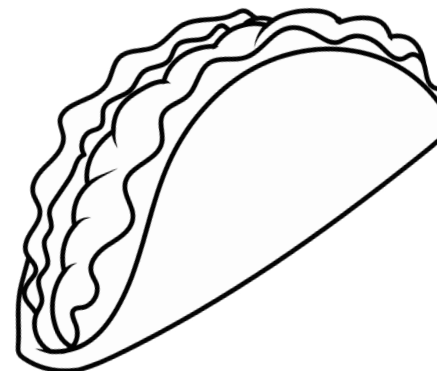
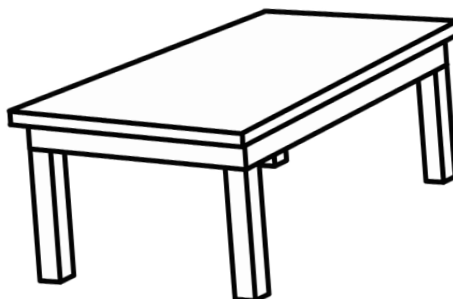

The Letter U

NAME: _____

Word search

V	N	M	U	T	M	V	I	S	C
T	T	K	G	E	U	M	U	B	N
S	O	R	F	N	Q	K	S	B	G
H	O	E	R	T	J	D	L	U	J
I	T	D	J	E	F	X	T	K	O
R	H	T	N	T	O	M	A	T	O
T	N	K	A	E	I	B	C	I	V
B	W	Q	R	B	E	F	O	E	Y
O	F	W	O	S	L	G	T	R	A
N	W	G	R	S	A	E	W	E	L

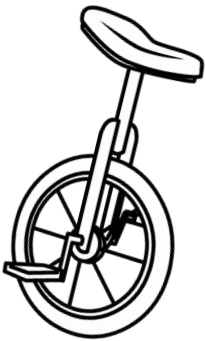
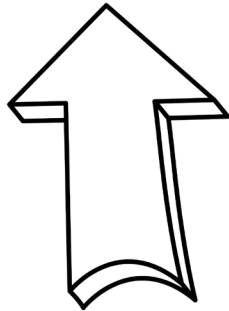

ukulele
umbrella
unicycle
unicor

up
universe
united states

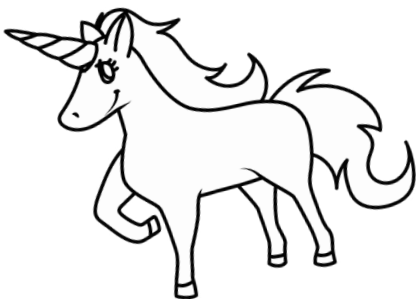

The Letter V

NAME: _____

Word search

V	V	F	J	D	J	F	Y	I	P
I	E	U	N	Q	G	V	V	P	C
O	S	G	C	I	L	O	A	A	X
L	T	C	E	Z	I	B	C	S	N
I	O	R	S	T	O	V	U	X	E
N	S	Q	J	T	A	T	U	M	B
H	T	G	K	J	X	B	M	H	O
I	X	F	Y	C	E	C	L	T	Z
B	L	V	U	L	T	U	R	E	Z
C	E	X	G	V	T	N	Q	A	E

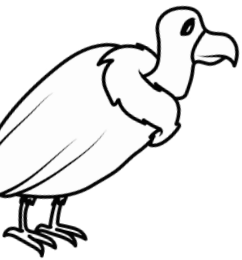
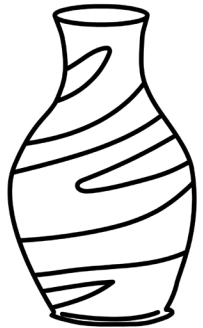

van
vase
vest
vegetable

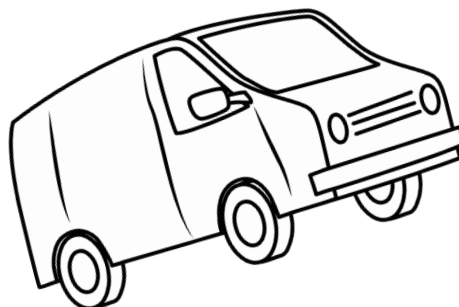

vulture
violin
vacuum

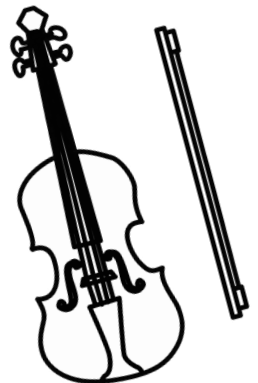

The Letter W

NAME: _____

Word search

D	L	F	V	E	I	A	L	Z	W
W	W	H	W	H	E	E	L	Z	A
Y	H	W	O	I	I	O	D	X	T
J	F	A	P	H	N	Q	K	G	C
E	R	L	L	Y	C	D	H	P	H
N	N	L	R	E	F	G	O	W	C
H	Y	E	J	O	Z	F	B	W	G
J	H	T	P	L	Z	B	B	J	W
U	X	W	I	E	W	A	G	O	N
W	A	T	E	R	M	E	L	O	N

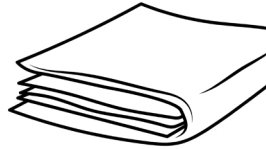
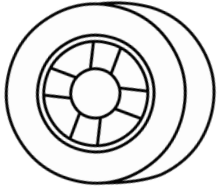

Whale
wheel
wallet
watermelon

wagon
window
watch

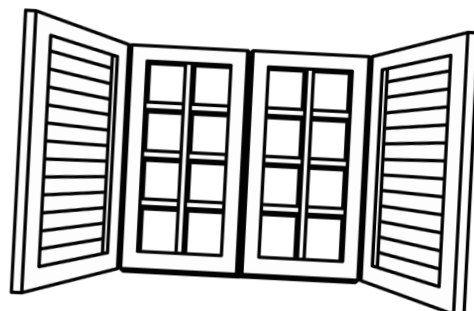
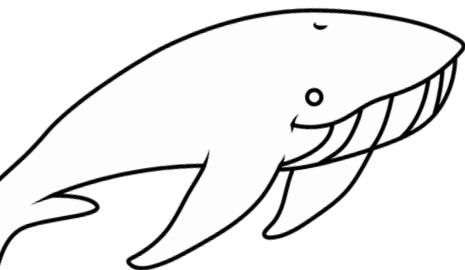

The Letter X

NAME: _____

Word search

M	W	A	C	C	L	Q	M	M	F
K	F	L	T	C	N	C	U	Q	F
M	R	Y	X	R	A	Y	B	I	E
S	U	Z	K	S	E	J	L	O	T
I	V	V	H	D	H	X	D	Z	X
X	Q	B	E	U	U	Z	O	N	A
Z	O	Y	C	V	V	J	A	X	M
T	A	P	Q	F	M	T	Y	H	C
Z	I	P	A	P	O	I	L	S	I
A	I	S	C	C	G	X	X	S	E

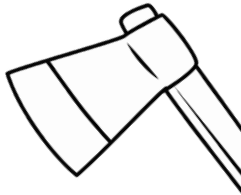
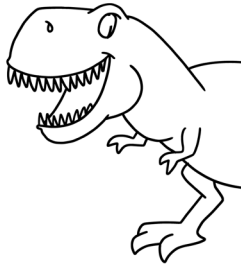
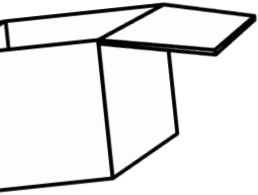

x-ray
mix
fox
box

six
t-rex
ax

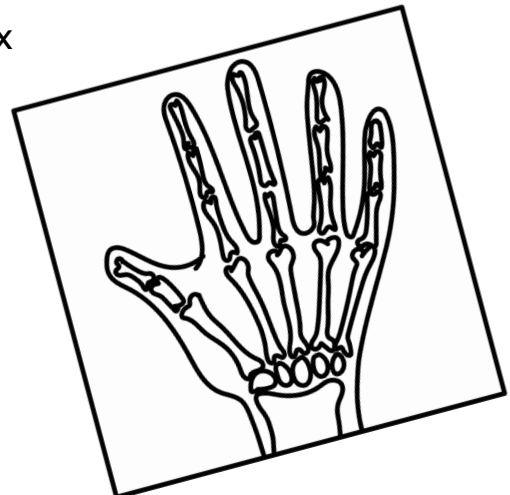
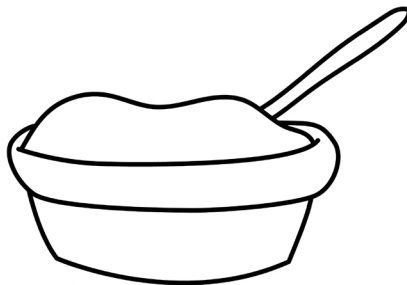
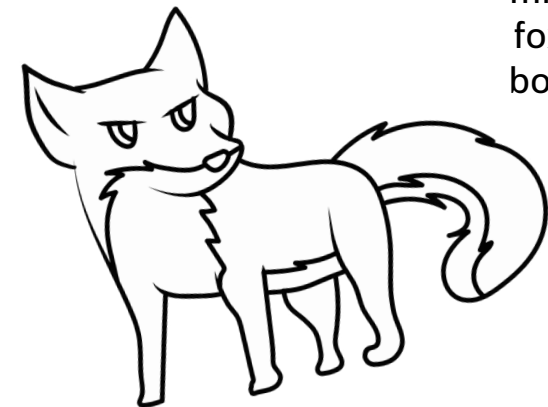

The Letter Y

NAME: _____

Word search

L	I	M	D	G	Y	A	K	Z	U
Y	E	L	L	O	W	S	D	U	N
N	P	D	Z	E	I	E	G	K	B
S	F	Q	Y	A	C	H	T	K	L
O	L	M	M	O	E	N	S	F	O
T	T	P	N	X	R	E	M	D	J
V	G	Y	Y	A	A	K	J	D	P
D	X	A	Y	O	G	U	R	T	A
T	H	W	Q	U	Y	T	F	V	S
C	Z	N	S	R	B	O	J	Q	Q

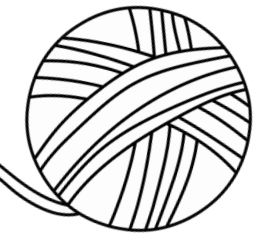
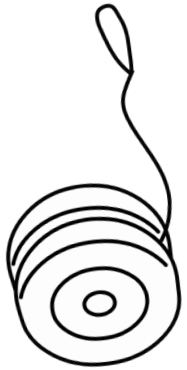

yo-yo
yacht
yarn
yogurt

yawn
yak
yellow

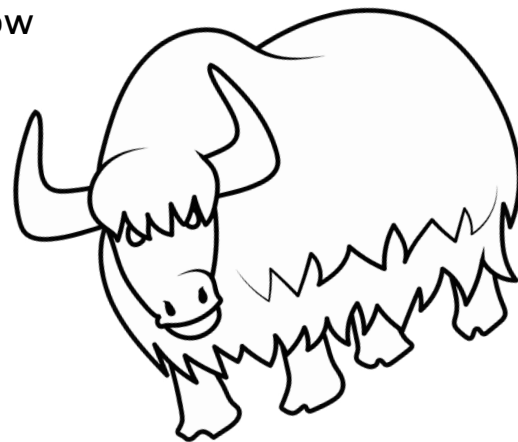

The Letter Z

NAME: _____

Word search

K	J	F	A	U	R	D	K	S	O
Z	Z	I	G	Z	A	G	T	T	Y
I	U	W	A	O	Z	E	R	O	I
T	Q	C	S	O	S	C	R	B	X
H	J	U	C	Z	E	M	D	N	D
E	J	X	V	H	E	E	S	K	T
R	L	W	Y	Z	I	B	G	I	W
B	J	C	S	P	P	N	R	L	V
Z	I	P	P	E	R	S	I	A	V
K	H	P	T	H	L	G	L	K	H

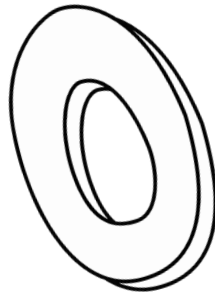
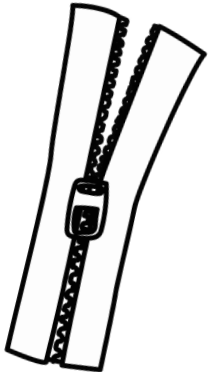
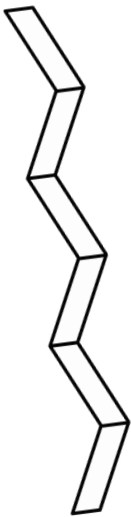

zebra
zipper
zero
zucchini

zigzag
zither
zoo

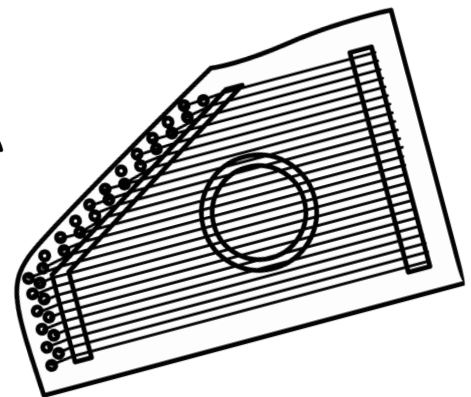
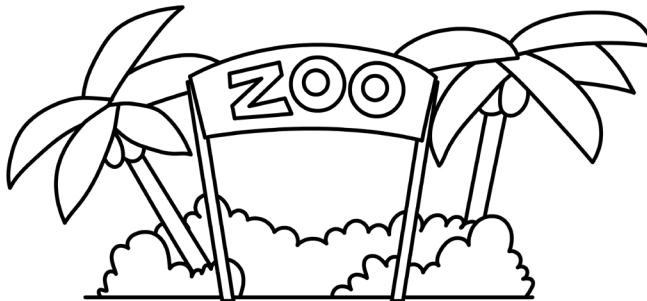
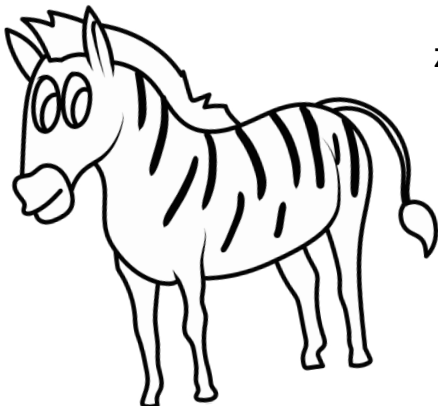

Tie My Shoe

NAME: _____

Shoe Tying & Lacing Practice (Get a grown up to help with cutting and glue!)

- 1.) Print this page out and cut off the directions.
- 2.) Glue the whole square with the shoes to some thin cardboard (like a used cereal box).
- 3.) After the glue is dry, you can color the shoes.
- 4.) Then, cut off the extra paper/cardboard around each shoe and use a single hole punch to punch holes where the shoelaces will go.
- 5.) Now you can practice tying or lacing your shoes! Tape the shoes to a table to keep them still when you tie.

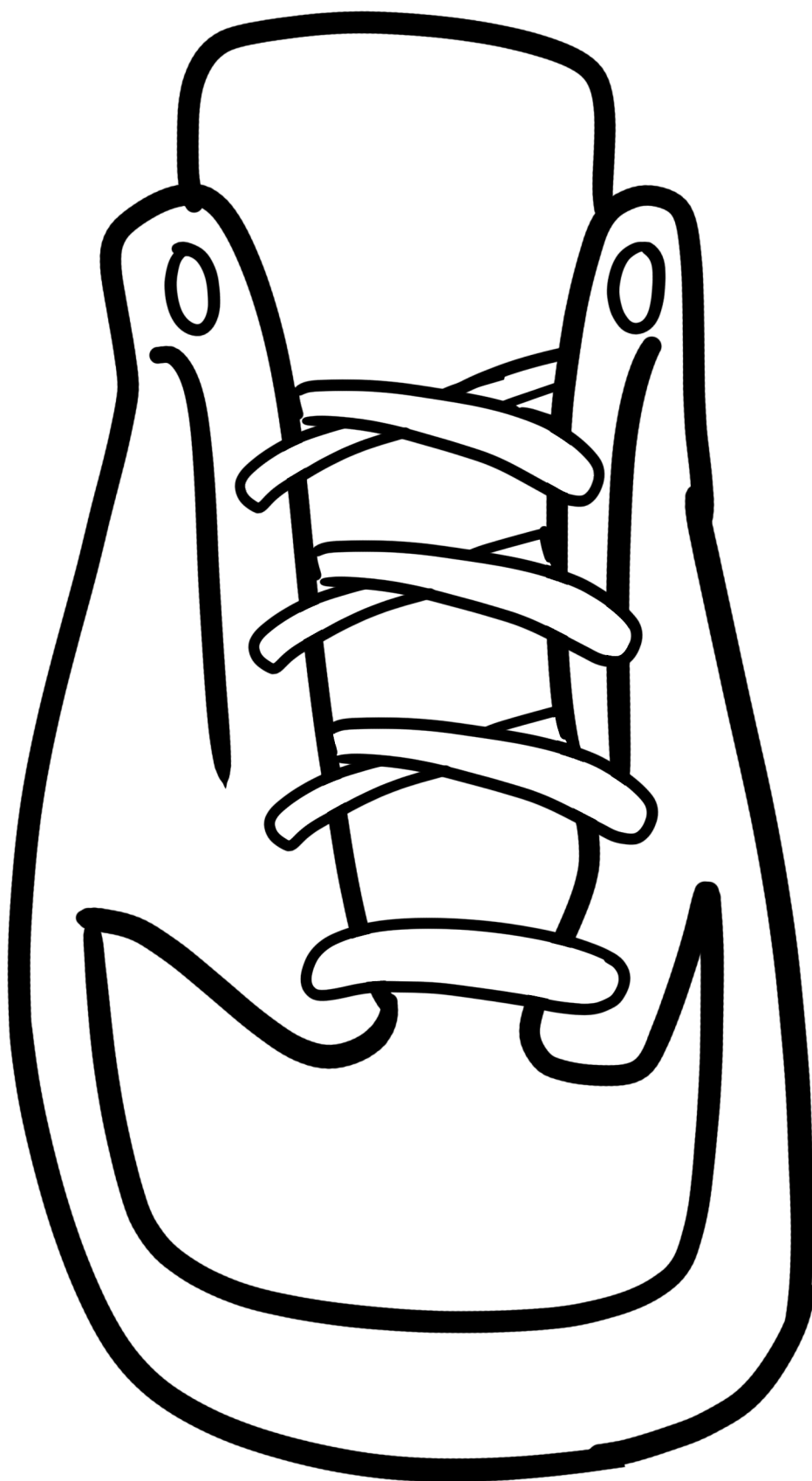

TR Blend Words

NAME: _____

Say the name of the picture. Fill in the letters that make the beginning sound.
Color the picture.

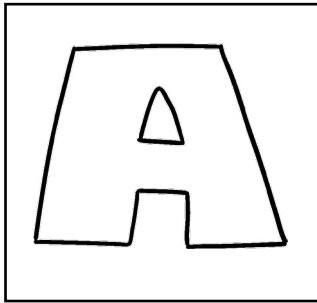

__ace

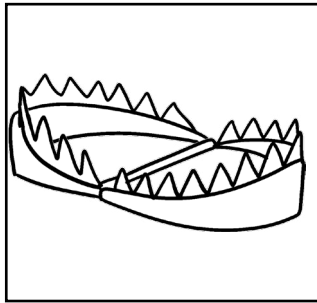

__ap

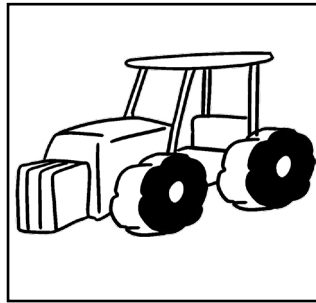

__actor

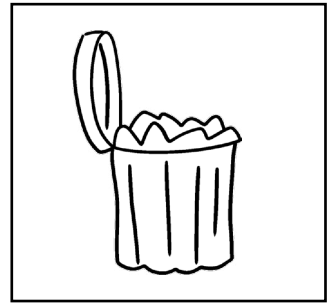

__ash

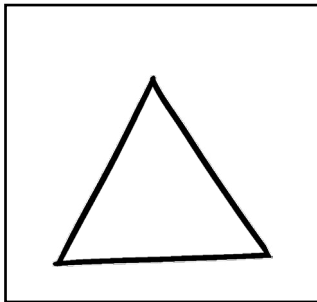

__iangle

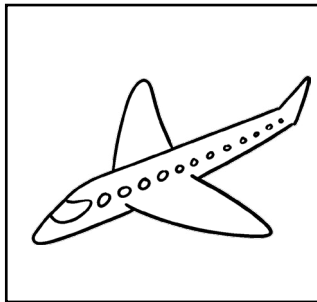

__avel

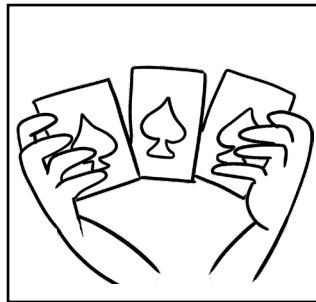

__rick

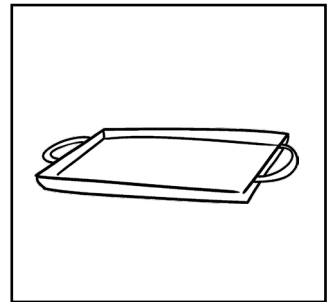

__ray

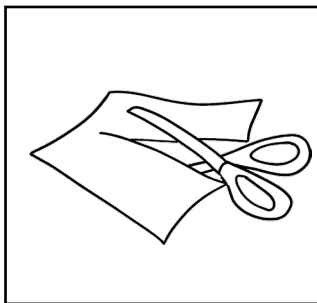

__im

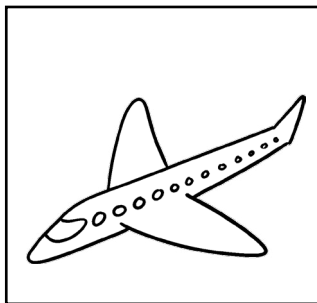

__ip

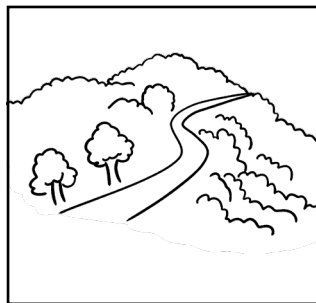

__ail

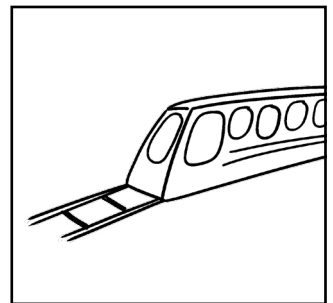

__ain

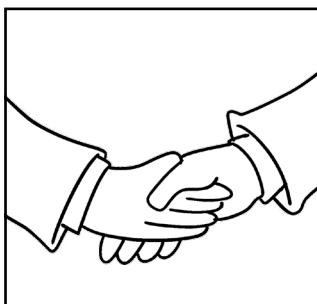

__eat

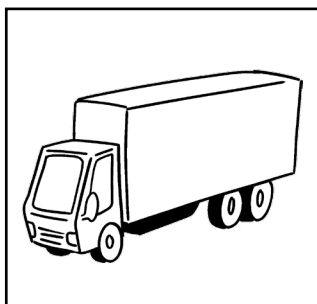

__uck

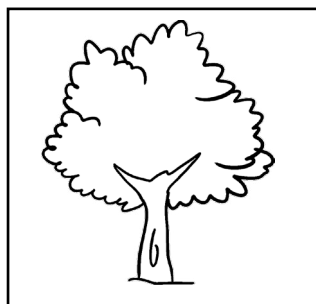

__ee



__y

Trick or Treat

NAME: _____

Coloring. Circle the witch, the ghost, the cat, the spider and the skull.



TW Blend Words

NAME: _____

Say the name of the picture. Fill in the letters that make the beginning sound.
Color the picture.

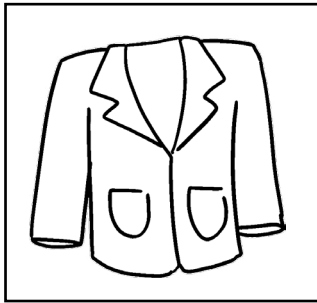

__eed

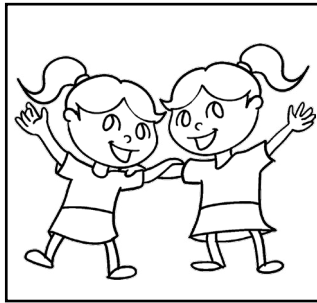

__ins

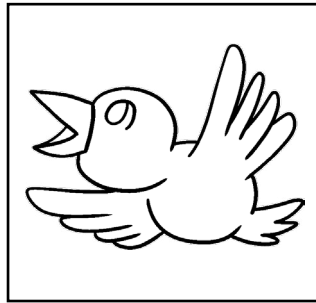

__eet

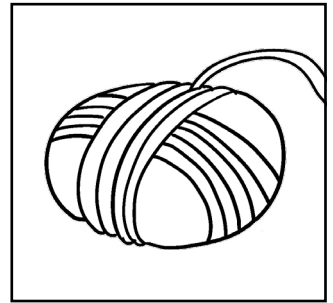

__ine

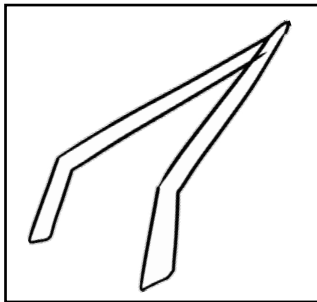

__eezers

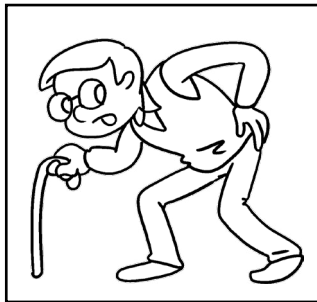

__inge



__elve

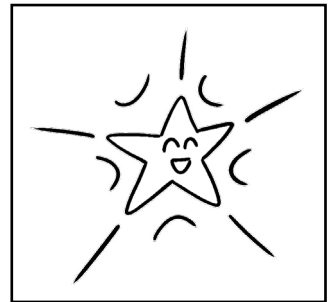

__inkle



__enty

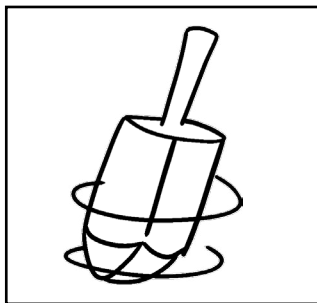

__irl

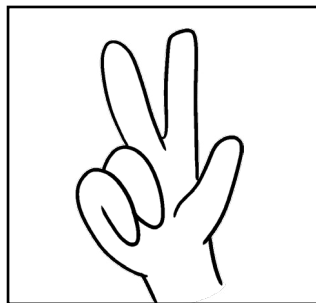

__ice

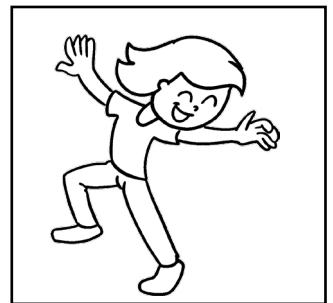

__ist

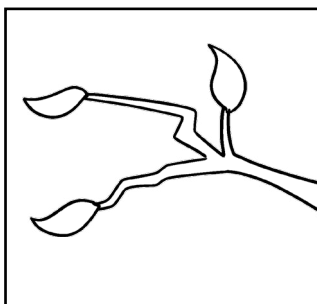

__ig

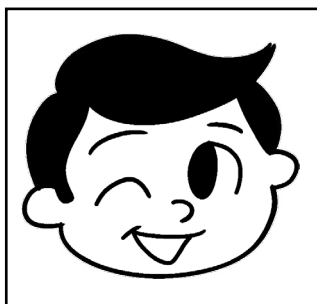

__itch

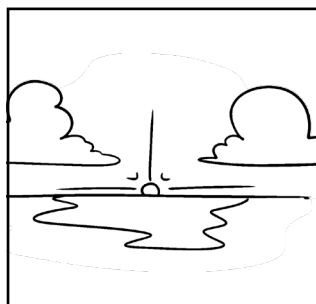

__ilight

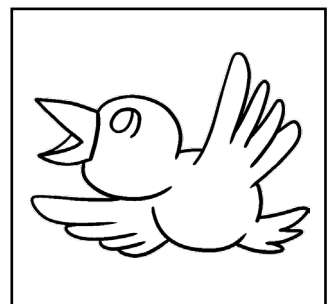

__itter

Two Little Birds

NAME: _____

Color the birds. Cut the birds and 2 rectangle strips out. Glue each strip into a circle and then glue one circle to the back of each bird. Use your finger puppets to sing along to the song.

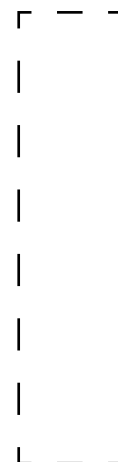
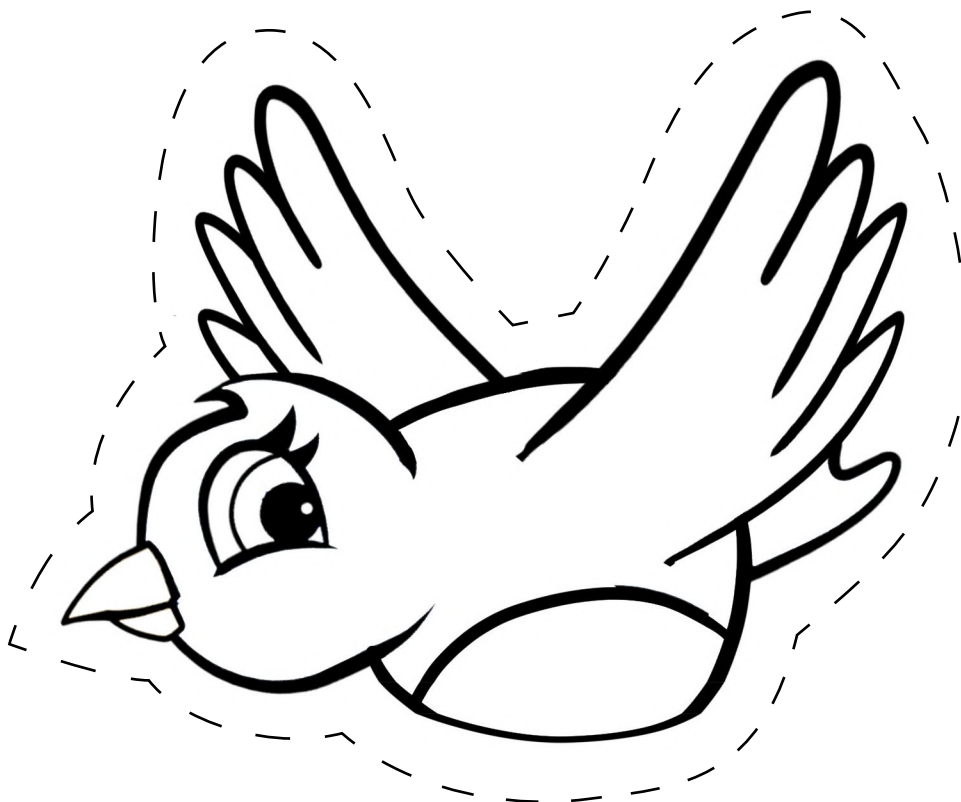
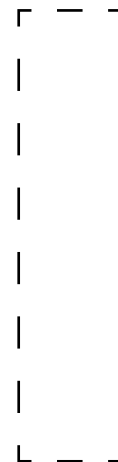
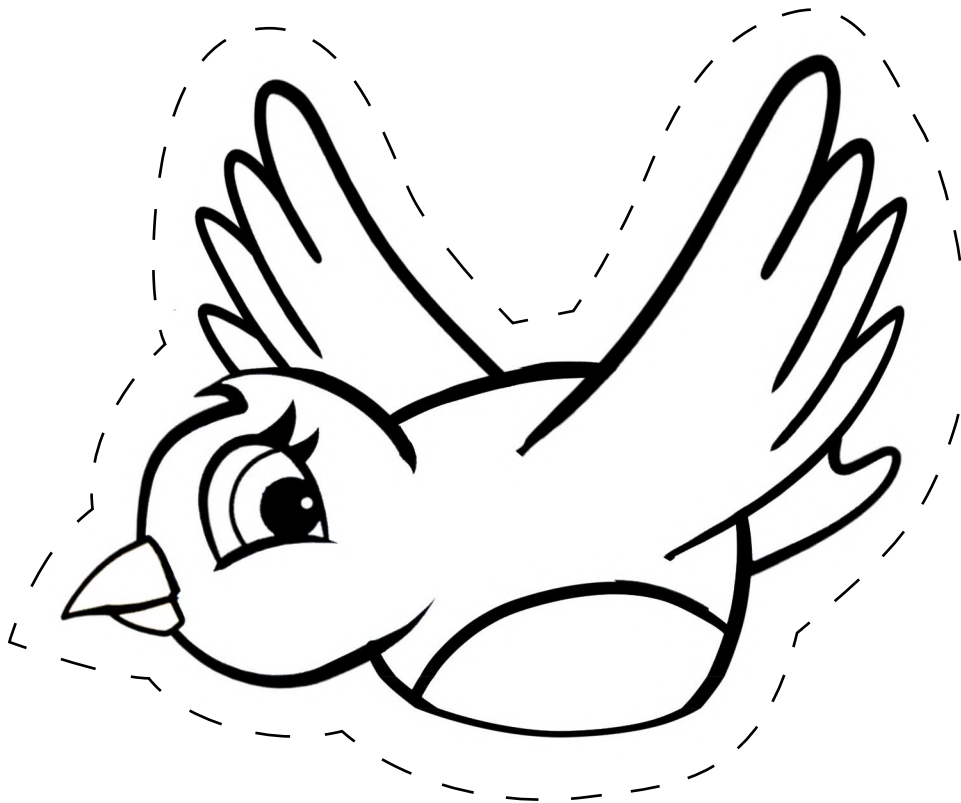

Unicorn

NAME: _____

Coloring

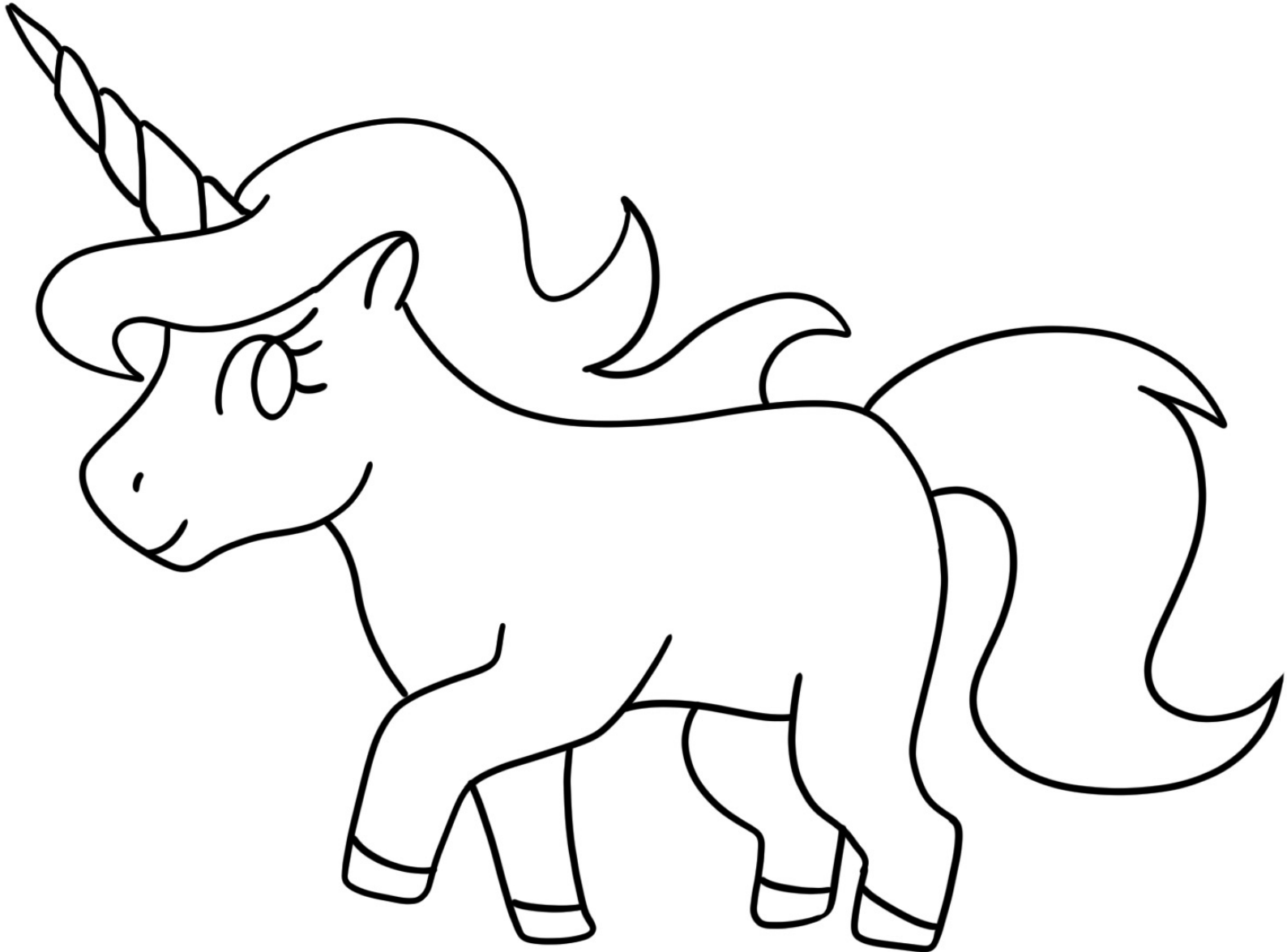

Walking One Day

NAME: _____

Find the animals. Circle the snake, tiger, bird, monkey, frog, bug, spider, mouse, butterfly, turtle, toucan.



Wash our Hands

NAME: _____

Color and cut out, then place in order the steps to wash your hands.

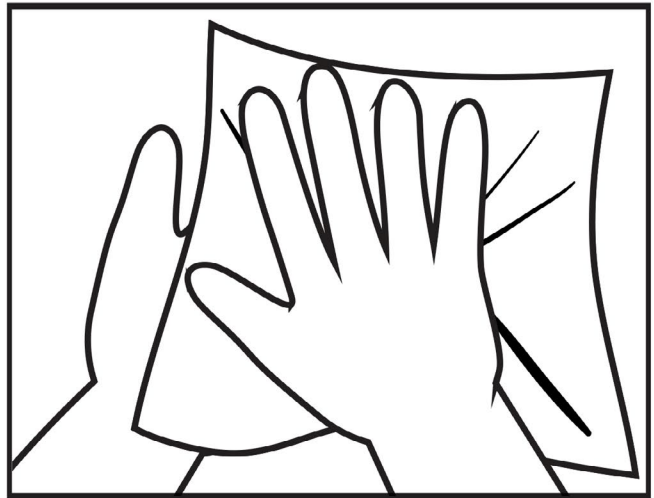
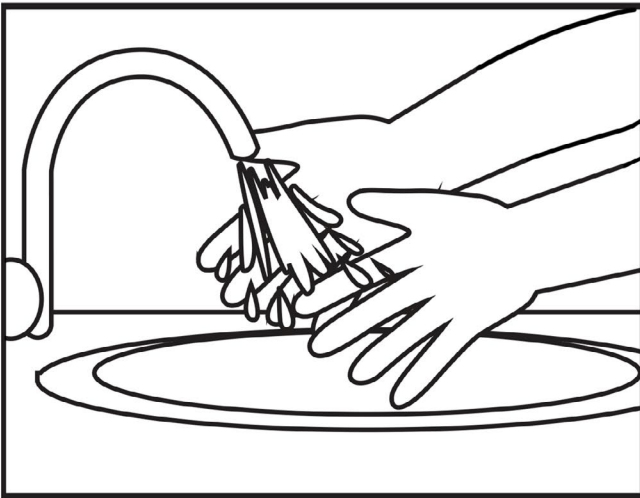
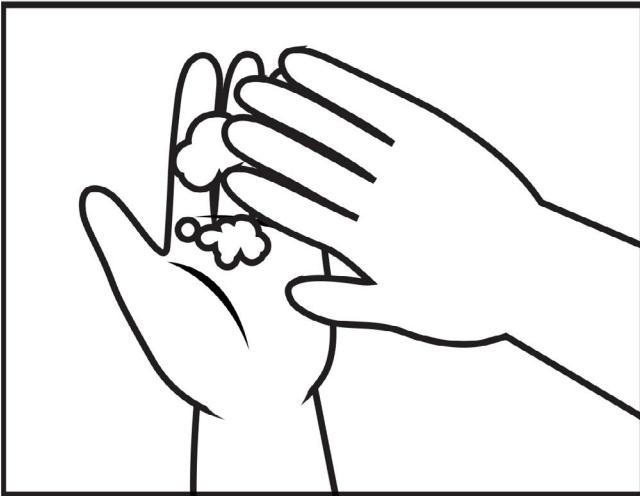
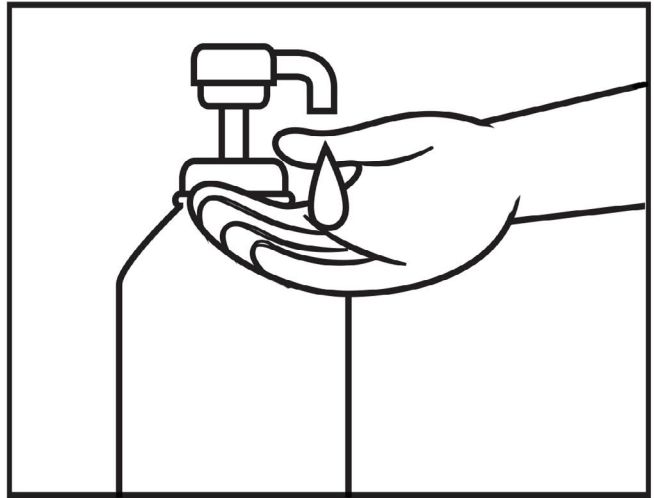
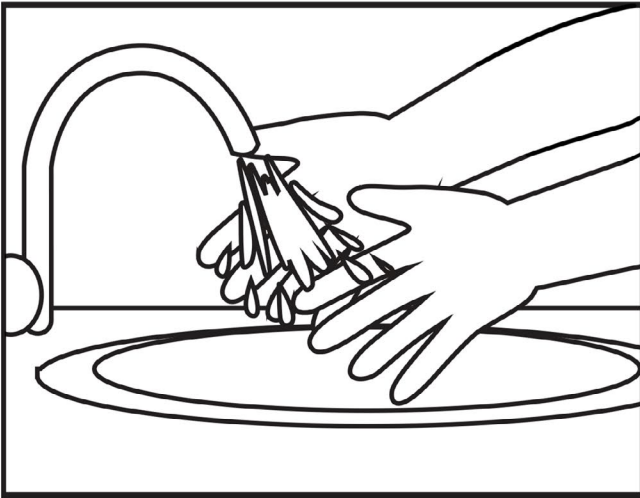

WH Blend Words

NAME: _____

Say the name of the picture. Fill in the letters that make the beginning sound.
Color the picture.

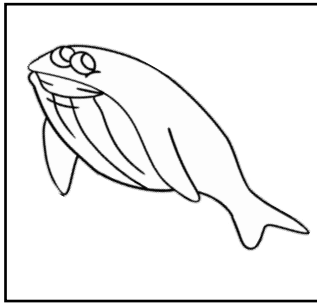

__ale

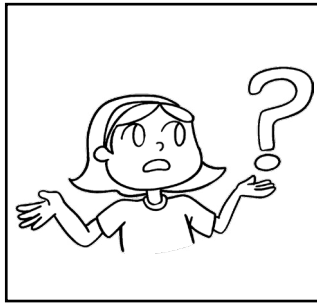

__ere

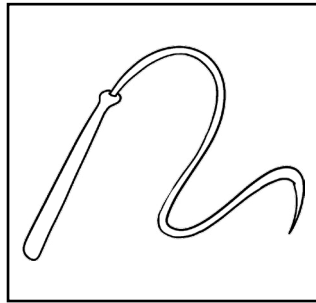

__ip

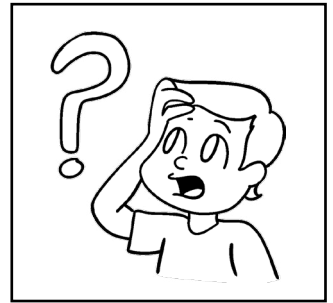

__at

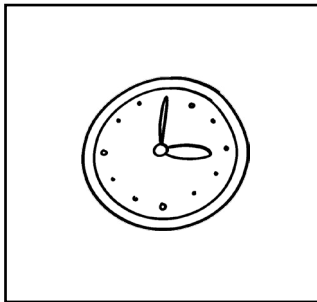

__ile

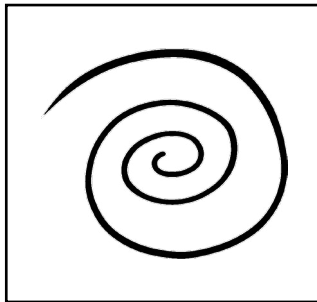

__irl

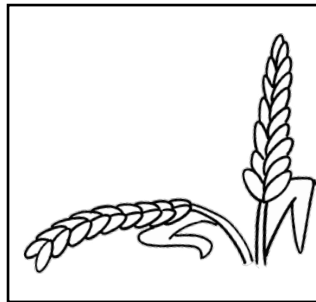

__eat

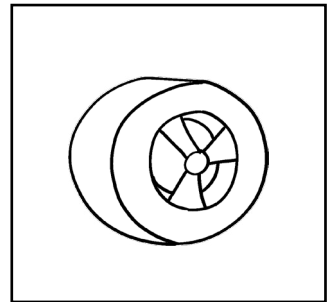

__eel

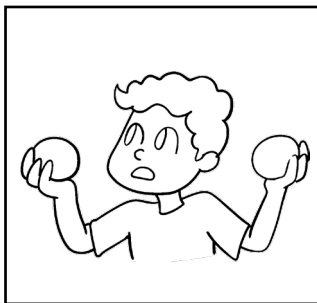

__ich

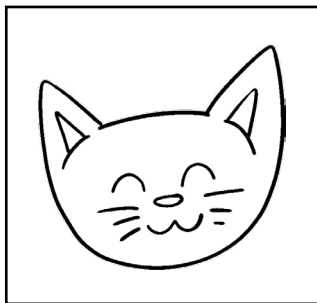

__isker

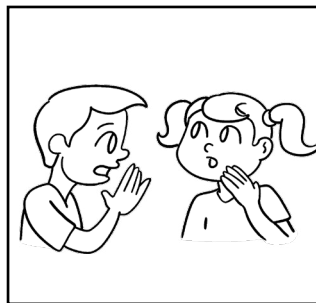

__isper

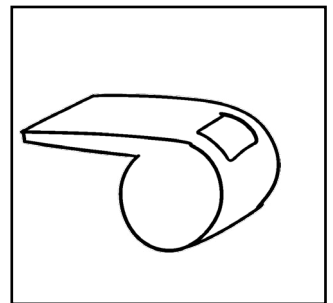

__istle

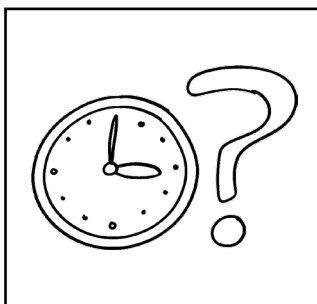

__en

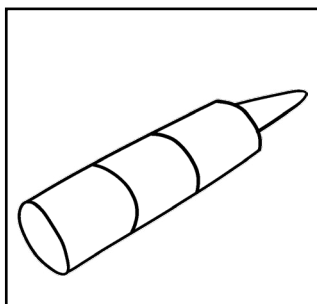

__ite

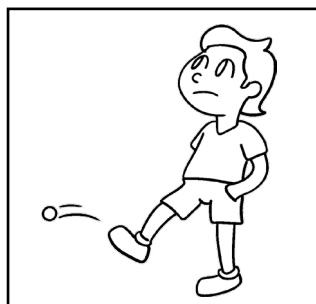

__enever



__y

What Time is It

NAME: _____

Write the time below each clock

